



Map Projections for Europe





Map Projections for Europe

Edited by:

A. Annoni¹, C. Luzet²,
E. Gubler³ and J. Ihde⁴

¹Joint Research Centre

²EuroGeographics

³Bundesamt für Landestopographie, Switzerland

⁴Bundesamt für Kartographie und
Geodäsie, Germany



LEGAL NOTICE

Neither the European Commission nor any person acting on behalf of the Commission is responsible for the use which might be made of the following information

A great deal of additional information on the European Union is available on the Internet.
It can be accessed through the Europa server (<http://europa.eu.int>).

Content

Foreword.....	7
Introduction.....	9
<i>Structure and Objectives of this Report</i>	9

JRC-EuroGeographics Map Projections Workshop

The workshop Summary - <i>Claude Luzet and Iain Greenway</i>	10
<i>Executive summary</i>	10
<i>The recommendations in short</i>	10
<i>Agenda</i>	10
<i>Represented bodies and organisations</i>	11
<i>Introduction</i>	14
<i>European coordinate reference systems</i>	15
<i>European needs</i>	15
<i>Map projections to be used for European purposes</i>	16
<i>Relationship with National Systems</i>	17
<i>Aspects to be further investigated</i>	17
<i>Results dissemination</i>	18

The EC requirements in terms of Projection Systems - <i>A. Annoni, J. Delincé, A. Wirthmann, C. Steenmans</i>	19
<i>Introduction</i>	19
<i>Use of projected data</i>	19
<i>New trend in EU policies related to geographic information</i>	20
<i>Examples of European requirements</i>	20
<i>Statistical Grids</i>	20
<i>Land Use/Cover Area Frame Statistical Survey (LUCAS)</i>	21
<i>The water directives</i>	22
<i>Natura2000</i>	23
<i>IMAGE 2000 and CORINE Land Cover 2000</i>	24
<i>Trans-European-Networks</i>	24
<i>Integrated Administration and Control System (IACS)</i>	25
<i>Agri-Environmental indicators</i>	26
<i>Conclusions</i>	27

Map Projections for the Layman - <i>Stefan A. Voser</i>	29
<i>From the Earth Surface to its representation on a Map</i>	29
<i>Flattening the Earth</i>	29
<i>Mapping Surfaces</i>	30
<i>Distortion Properties of Map Projections</i>	31
<i>The use of Map Projections</i>	32
<i>Projections and Change of Datum</i>	32
<i>Conclusions</i>	33
<i>References</i>	34

Coordinate Reference Systems used in Europe - Including Map Projections - <i>J. Ihde, J. Luthardt, C. Boucher, P. Dunkley, E. Gubler, B. Farrell, J.A. Torres</i>	35
<i>Introduction</i>	35
<i>Standardisation Activities</i>	35
<i>Coordinate Reference Systems</i>	36
<i>Coordinate Operations</i>	37
<i>Activities of EUREF and CERCO</i>	39
<i>Information system of European Coordinate Reference Systems</i>	39
<i>Map Projections and CRS used in Europe</i>	40
<i>Recommendations for pan-European Map Projections</i>	40
<i>References</i>	44
<i>Annex 1 - Schema for describing a coordinate reference system – example ETRS89/Cartesian coordinates</i>	45

<i>Annex 2 - Schema of describing a coordinate operation – example DE_DHDN to ETRS89</i>	46
<i>Annex 3 - Letter of CERCO and EUREF to the European National Mapping Agencies</i>	47
Problems and issues from the perspective of the National Mapping Agencies - <i>Lars E. Engberg</i>	48
<i>Background</i>	48
<i>The Use of Plane Coordinate-systems</i>	48
<i>A New Map Projection</i>	49
<i>Universal Transverse Mercator (UTM)</i>	49
<i>European Transversal Mercator (ETM)?</i>	49
<i>Summary</i>	49
An Equal Area Projection for Statistical Mapping in the EU - <i>Lysandros Tsoulos</i>	50
<i>Factors influencing the choice of a suitable projection</i>	50
<i>The projection to be used by EUROSTAT - GISCO</i>	52
<i>Conclusions</i>	55
<i>References</i>	55
<i>Acknowledgement</i>	55
New Map Projections for Ireland - <i>Iain Greenway</i>	56
<i>Background and context</i>	56
<i>The need for a new projection</i>	57
<i>Intended properties of the new projections</i>	57
<i>Comparison of the proposed projections</i>	59
<i>Analysis of proposed projections and their implications</i>	61
<i>References</i>	62
<i>Appendix A - Calculation of Scale Factor on the Central Meridian for ITM</i>	62
<i>Appendix B - Comparison of Projection Types</i>	63
European Map Projections and Transformation Procedures. Experiences from the SABE Project - <i>H. Bennat, J. Brennecke, M. Duster, A. Illert, W. Mehlitz, I. Naumann</i>	64
<i>Introduction</i>	64
<i>Map Projections</i>	64
<i>SABE</i>	64
<i>Transformation Procedure</i>	66
<i>Remarks</i>	70
<i>References</i>	71
The Future of Coordinate Reference Systems - <i>Stefan A. Voser</i>	72
<i>Introduction</i>	72
<i>Digital Geospatial Management (DGM)</i>	72
<i>Coordinate Reference System Management (CRSM)</i>	72
<i>Current situation of CRSM in Europe</i>	73
<i>The User's need of CRSM</i>	74
<i>Coordinating CRSM Activities</i>	74
<i>Conclusions</i>	75
<i>References</i>	75
Identification, documentation and classification of map projections - <i>Peter Mekenkamp</i>	76
<i>Introduction</i>	76
<i>Identification</i>	76
<i>Classification</i>	76
<i>Rules for choosing a map projection</i>	76
<i>New developments</i>	77
<i>Extent of the area</i>	77

<i>Purpose of the map</i>	78
<i>Classification parameters</i>	78
<i>Projection Accuracy Analyses</i>	78
<i>Conclusions</i>	81
A unique European cartographic projection system - Can it really not be proposed? - Manfred Oster	82
<i>Current situation in Europe</i>	82
<i>The Spatial Reference System ETRS89 as basis towards a unique cartographic projection</i>	82
<i>Two levels of using a common projection system</i>	82
<i>Changes of cartographic projection systems in Germany during the last 100 years</i>	83
<i>Costs</i>	83
<i>German contribution to a unique cartographic projection system</i>	84
<i>Conclusions</i>	84
<i>References</i>	84
Projections in small scale atlases - Christoph Brandenberger	85
<i>Introduction</i>	85
<i>Important parameters for choosing an optimal map projection</i>	85
<i>Projections in the Swiss School Atlas (SWA)</i>	88
<i>Suitable map projections for CORINE project</i>	88
<i>Questions</i>	91
<i>Demonstration of an on-line map projection tool</i>	91
<i>References</i>	92
List of workshop participants	93

Technical Details of the EVRS

The Vertical Reference System for Europe - J. Ihde, W. Augath	95
<i>Introduction</i>	95
<i>Present status</i>	95
<i>United European Levelling Network (UELN)</i>	95
<i>European Vertical Reference Network (EUVN)</i>	96
<i>European Vertical Reference System (EVRS)</i>	96
<i>References</i>	97
European Vertical Reference System (EVRS)	98
<i>Preamble</i>	98
<i>Definition</i>	98
<i>The European Vertical Reference Frame 2000 (EVRF2000)</i>	98
<i>The Adjustment of UELN-95/98</i>	99
<i>Addendum</i>	100
<i>European Spatial Reference System</i>	102
<i>Geodetic Reference System 1980 (GRS80)</i>	105
<i>Definition</i>	105
<i>Related Resolutions</i>	106
<i>References</i>	109

Technical Description of European Conventional Coordinate Reference Systems

ETRS89 Ellipsoidal Coordinate Reference System (ETRS89)	110
<i>Relationship between ellipsoidal and Cartesian coordinates</i>	110
<i>Conversion formulas</i>	110

ETRS89 Transverse Mercator Coordinate Reference System (<i>ETRS-TMzn</i>)	113
<i>Conversion formulas</i>	116
ETRS89 Lambert Conformal Conic Coordinate Reference System (<i>ETRS-LCC</i>).....	119
<i>Conversion formulas</i>	121
ETRS89 Lambert Azimuthal Equal Area Coordinate Reference System (<i>ETRS-LAEA</i>).....	123
<i>Conversion formulas</i>	124
Appendix 1 - Brief Biographies of the Workshop Participants.....	126
Appendix 2 – Contributors.....	130

Foreword

There is a growing awareness at different governmental levels that cross-sectoral integrated assessment is paramount to ensure economic and social cohesion, sustainable development, and competitive but mutually supportive regional development. Environmental phenomena are not limited to national boundaries. There is a clear need to support a comprehensive concept of spatial development that has an integrated, relevant scope and facilitates more balanced, effective and responsible land-use and better management of the EU's natural, human and technological resources. Applications based on integrated assessment require harmonised and interoperable layers of relevant spatial information. Unfortunately Europe is a patchwork of several countries with different traditions in terms of their geographic choices and in order to have comparable data or better to build a European Spatial Data Infrastructure several aspects need to be analysed.

In December 1999 in a first workshop organised by the Joint Research Centre and MEGRIN the need of a common Spatial Reference System for Europe was discussed as first step to ensure that geographic data are compatible across Europe. There was consensus amongst the experts that the ETRS89 Ellipsoidal Coordinate Reference System [ETRS89] is the system to adopt at European level and several countries have already done so. The European Commission is now facing the problem of cartographic representation and grid storage of pan-European geographic data at different levels of precision. The current situation in Europe (5 different types of reference ellipsoids and 8 different types of cartographic projections are used in the 37 different CERCO member or observer countries) is not simple. How could the European countries could agree on one single projection system and which one should be selected? Which member countries would be able to afford the costs for changing their system? Can a unique map projection be proposed? To discuss this subject the Joint Research Centre asked EuroGeographics to organise a second workshop in December 2000 which the main objective was to analyse the European Commission primary needs for map projection(s) and obtain expert advice to select an appropriate set of European Conventional Reference Systems.

While unanimity was easily reached in 1999, this second Workshop had much more difficulties to reach a consensus. The main reason is that, while a unique Spatial Reference System is nearly totally scale- and application-independent, this is not the case with Map Projections. Debates have been very rich, and convergence was gradually achieved on a set of recommendations, but also on the need for further work, from the experts (to clarify some technical issues and definitions. So on the analysis of possible options (e.g. Lambert or Albers?, UTM with exceptions or not?...) has continued through the generous contributions of the participants.

After one year of work and consultation with several organisations the European Conventional Reference Systems to be recommended to the European Commission for adoption have been finally defined.

I want personally thank all experts who contributed to the achievement of the results and in particular the experts of the 'workshop editing committee', Iain Greenway who chaired the editing committee, Claude Luzet, the 'workshop panel' (Christoph Brandenberger, Johannes Ihde, Lysandros Tsoulos, Stefan A. Voser, etc...), the 'workshop facilitator' Roger Lott and the other experts from the CERCO WG8 and the EUREF working group 'transformation' (Josef Adam, Bjorn Geirr Harsson, Johannes Ihde, Joao Torres and Erich Gubler) that developed the technical annex after the workshop. Finally I want to thank my colleagues of the European Commission and in particular Albrecht Wirthmann for his excellent technical support.

Alessandro Annoni
*Joint Research Centre
Institute for Environment and Sustainability*

Introduction

The background to this report is a two-days workshop organised by the Joint Research Centre of the European Commission in partnership with EuroGeographics. The meeting was hosted by EuroGeographics, the European organisations representing National Mapping Agencies, on the 14-15 December 2000 at its offices in Marne la Vallée. Due to the difficulty of problems and options analysed, it was not possible to finalise the recommendations during the workshop and it was so necessary to continue the work by remote consultation. In this second phase it was decided to directly involve the CERCO WG8 and the EUREF working group 'transformation' to fully develop the technical details of the European conventional Coordinate Reference Systems to be adopted by the European Commission.

The main objectives of this report are:

1. To provide a coherent overview of the current situation in Europe about coordinate reference systems,
2. To provide technical element and references to understand the related issues,
3. To analyse the European Commission requirements and propose a set of technical solutions to be adopted by the European Commission as European conventional Coordinate Reference Systems,
4. To identify other recommendations or areas of future investigation.

The report is structured in 3 parts: the first part illustrates the results of the Map Projection workshop; the second part provides the technical details of the European Vertical Reference System (EVRS), and the last part includes the technical description of the proposed European conventional Coordinate Reference Systems (CRS).

Structure and
Objectives of
this Report

The workshop Summary - *Claude Luzet, Iain Greenway*

Executive summary

The Map Projections Workshop was organised by EuroGeographics following a request from the Joint Research Centre of the European Commission. Its objective, to be achieved by discussion amongst leading experts from the field of European geodesy and GI, was to examine the options and issues concerning suitable map projections for spatial data for use by the Commission in its activities. The Workshop took as the European Commission's area of interest the current 15 member states, plus European Free Trade Association and the 13 current candidate countries.

Debates have been very rich, and convergence was gradually achieved on a set of recommendations. By its acceptance the European Commission would promote widespread use of the de facto standard for future pan-European data products and services.

The recommendations in short

The workshop recommends to the European Commission:

1. To reaffirm the recommendations of the November 1999 Workshop on Spatial Reference Systems, i.e. to adopt ETRS89 as geodetic datum and to express and store positions, as far as possible, in ellipsoidal coordinates, with the underlying GRS80 ellipsoid [ETRS89]. To further adopt EVRF2000 for expressing practical heights (gravity-related).
2. Recognising that the EC needs cannot be met through usage of the ETRS89 ellipsoidal coordinate reference system [ETRS89] alone, and map projections are required to supplement the ellipsoidal system:
 - To adopt ETRS89 Lambert Azimuthal Equal Area coordinate reference system of 2001 [ETRS-LAEA], for statistical analysis and display.
 - To adopt ETRS89 Lambert Conic Conformal coordinate reference system of 2001 [ETRS-LCC] for conformal pan-European mapping at scales smaller or equal to 1:500,000.
 - To adopt ETRS89 Transverse Mercator coordinate reference systems [ETRS-TMzn], for conformal pan-European mapping at scales larger than 1:500,000.
3. To take strong action to support the work of EUREF, EuroGeographics and the NMAs in collecting and making publicly available the definitions of various coordinate reference systems, and definitive transformation parameters between ETRS89, EVRF2000 and national systems.

Agenda

Problem definition - User Perspective and Problem Statement

- The EC requirements in terms of map projections - *Alessandro Annoni*
- Round Table on EC needs - *Alessandro Annoni, Albrecht Wirthmann, Jacques Delincé, Chris Steenmans, Vanda Perdigao, J.F. Dallemand.*

Updating from last workshop on "Spatial Reference Systems"

- ETRS89 and EVRS - *Johannes Ihde.*

Problem definition - Technical Perspective

- Introduction to map projections, *Stefan A. Voser*
- Review of the current situation within Europe, *Johannes Ihde*
- Problems and issues from the perspective of the NMAs, *Lars Engberg.*

Approaches in each of the main cartographic areas - thematic, large scale, small scale, raster

- An Equal Area Projection for Statistical Mapping in the EU - *Lysandros Tsoulos*
- New Map Projections for Ireland - *Iain Greenway*
- European Map Projections and Transformation Procedures - Experiences from the SABE Project - *Heinz Bennat.*

Some possible approaches to solving the EU/EC problems

- Common European Chorological Grid Reference System - *M. Roekaerts*
- The future of Coordinate Reference Systems - *Stefan A. Voser*
- Identification, documentation and classification of map projections - *Peter Mekenkamp*
- A unique European Map Projection for all National Mapping Agencies (NMA) - Can it really not be proposed? - *Manfred Oster*
- Approaches in small scale atlases - *Christoph Brandenberger*.

Panel discussion

- Determine how to best satisfy the EC/EU needs - *Roger Lott* (facilitator)
- Summary and conclusions - *Claude Luzet*.

Leading experts from the field of Geodesy, Cartography and Geographic Information Systems were invited to the workshop. They well represent standardisation organisations, GIS industry, users of European data, European data providers, ...

Represented bodies
and organisations

The Joint Research Centre (JRC) is the European Union's scientific and technical research laboratory and an integral part of the European Commission. The JRC is a Directorate General, providing the scientific advice and technical know-how to support EU policies. Its status as a Commission service guarantees the independence from private or national interests, which is crucial for pursuing its mission. The Institute for Environment and Sustainability (IES) is one of the seven JRC institutes. The mission of IES is to provide scientific and technical support to EU strategies for the protection of the environment and sustainable development. Prime objectives of IES are to investigate the level and fate of contaminants in the air, water and soil; assess the effects of these contaminants upon the environment and individuals; and promote a sustainable energy supply. Its integrated approach combines expertise in experimental sciences, modelling, geomatics and remote sensing. This puts the institute at the forefront of European research for the attainment of a sustainable environment. The JRC GI&GIS Project has the mission to facilitate "Geographic Information harmonisation and interoperability" at European level supporting the actions to create a European Spatial Data Infrastructure.

JRC/IES

The statistical office of the Commission has for mission "to provide the European Union with a high-quality statistical information service. More specifically, this consists of:

- Providing the European institutions with statistical information for devising, managing and assessing common policies;
- Setting up a European statistical system using a common language linking the national statistical systems;
- Supplying the general public with statistical information, including the use of new electronic media;
- Offering technical cooperation with the rest of the world".

EUROSTAT/GISCO

GISCO (Geographic Information System of the COMmission), is the sector of EUROSTAT responsible for managing the geographical reference database for the European Commission. Additionally GISCO promotes and participates in Commission activities in the field of GI and GIS. Within the European statistical system, GISCO ensures standardisation and harmonisation in the exchange of geographical information between Members States and EUROSTAT.

The European Environment Agency (EEA) was launched by the European Union (EU) in 1993 with a mandate to orchestrate, cross-check and put to strate-

EEA

gic use information of relevance to the protection and improvement of Europe's environment. Current membership includes all 15 EU states, as well as Iceland, Liechtenstein and Norway. Mission statement: "The mission of the EEA aims to support sustainable development and to help achieve significant and measurable improvement in Europe's environment through the provision of timely, targeted, relevant and reliable information to policy making agents and the public".

EUREF EUREF (EUropean REFerence Frame) is the name of a network of geodetic stations as well as the name of the Sub-Commission for Europe (former EUREF and UELN/REUN) of the Commission X of IAG (International Association of Geodesy), created in 1987 as a successor of RETRIG.

The purpose of the IAG Commission X on Global and Regional Geodetic Networks (GRGN) is to focus on the variety of existing control networks (horizontal or vertical, national or continental, global from space techniques) as well as their connections and evolutions.

The Commission X has two types of subdivisions:

- Subcommissions for large geographical areas: such subcommissions will deal with all types of networks (horizontal, vertical and three dimensional) and all related projects which belong to the geographical area,
- Working Groups for specific technical topics.

CERCO WG8 CERCO (Comité Européen des Responsables de la Cartographie Officielle) is the group of 37 European National Mapping Agencies (NMAs) represented by their Heads. The mission of CERCO is to help all its members to meet both national and Europe-wide needs for their mapping and geospatial information. CERCO's principal objective is to ensure that its members have a key role in developing the European geospatial information industry and, thereby, that investments by national governments in their country's mapping are used to the best advantage of the wider European Community. CERCO achieves this through the efforts of its Management Board, Secretariat, Work Groups, MEGRIN, and individual members.

Work Group 8 of CERCO deals with issues related with geodesy.

EuroGeographics (MEGRIN) MEGRIN was created in 1993 on the initiative of CERCO with the aim of helping the National Mapping Agencies (NMAs) of Europe to meet the increasing demand for cross-border products and services. Since November 1995 MEGRIN has had the legal statute of a GIE (Groupement d'Intérêt Economique, i.e. Economic Grouping of Interest) according to French law. MEGRIN's members, which are also CERCO members, have signed the GIE agreement and pay an annual membership fee to MEGRIN. There are today 20 MEGRIN members and other CERCO members also take part in the life of MEGRIN as observers. MEGRIN is an acronym of "Multipurpose European Ground Related Information Network", it is a European network of geographical referenced information for use in many diverse applications. MEGRIN's budget is derived primarily from the financial contributions of its members, and from the incomes of its first commercial product SABE (Seamless Administrative Boundaries of Europe). MEGRIN also takes part in several projects partly funded by the European Commission.

On 1st January 2001, MEGRIN and CERCO have merged to create a new organisation; EuroGeographics "Europe's National Mapping Agencies working for the European Geographic Information Infrastructure".

Ordnance Survey Ireland Ordnance Survey Ireland is the national mapping agency of Ireland, responsible for creating, maintaining and making available to users definitive and

authoritative mapping databases (at a variety of scales) of the state, and the underlying infrastructure and reference systems to support those databases and related applications. It is also the adviser to government on matters relating to mapping, geographic information and the development of national spatial data infrastructures, and represents the state at international level on matters relating to mapping and geographic information.

Within Germany, each Land or federal state has responsibility for land surveying and cadastral activities. Within the area of map projections, this includes:

- production, renewal and preservation of geodetic reference points,
- creation, update and supply of geotopographic information (vector-based ATKIS-data),
- collection of aerial photographs and other remote sensing images,
- publication of official topographic and thematic maps.

In the workshop, the Länder were represented by:

- Bayerisches Landesvermessungsamt (BLVA), and
- Landesvermessungsamt Nordrhein-Westfalen (LVermA NRW).

German Länder
(states)

The Bundesamt für Kartographie und Geodäsie (BKG) is a Federal German authority. It maintains technical contacts with similar institutions abroad and it takes part in scientific work for special projects as well as being an active member of international scientific organisations.

BKG

The BKG has the following central tasks:

- in the fields of cartography/geoinformation the editing, updating, and provision of analog and digital topographic data as well as the further development of the relevant procedures and methods, and
- in the geodetic field the provision and maintenance of the geodetic reference networks of the Federal Republic of Germany including the relevant surveying techniques and theoretical work on the acquisition and editing of the measuring data, and also the cooperation in bilateral and multilateral activities on the determination and updating of global reference systems as well as on the further development of the measuring and observation techniques employed.

The internet collection of European Map Projections and Reference Systems is a private initiative to help users when having georeferencing problems. It is built up by Stefan A. Voser since 1996 (<http://www.mapref.org>).

MapRef

The Federal Office of Topography is the governmental agency responsible for geodetic reference networks, geodetic and cadastral surveying, topographic mapping and spatial data for GIS in Switzerland. It is responsible for establishing the national geodetic and levelling networks, permanent GPS stations and positioning services, for producing aerial photographs, national maps at scales of 1:25,000 and smaller, interactive map applications, as well as digital cartographic and topographic databases.

L+T

The National Land Survey of Sweden is responsible for developing and maintaining an effective infrastructure within the real property sector and for furnishing basic information about the landscape and properties, as well as conducting commissioned activities in connection with this.

NLS Sweden

The IGN has the following objectives:

- to carry out, on the national territory, the operations required for the implantation and maintenance of a geodetic network and a precise level-

IGN-France

- ling network, for the aerial photographic coverage and for the production and revision of topographic base maps and derived maps;
- to carry out operations concerning aerial and spatial remote sensing for surveying purposes, the digitisation of cartographic data and the production of thematic maps;
- to produce, publish or distribute the corresponding documents in graphic, photographic or digital form.

Institut für Kartographie,
Switzerland

The Institut für Kartographie is part of the Swiss Federal Institute of Technology Zurich (ETH Zurich) - an institution of the Swiss Confederation dedicated to higher learning and research.

European Topic
Centre on Nature
Conservation
(EEA-ETC/NC)

The European Topic Centre on Nature Conservation (EEA-ETC/NC) is one of the 8 topic centres created by the European Environment Agency (EEA) since December 1994 to collect, analyse, assess, synthesise the information on environment in Europe.

The EEA-ETC/NC is composed of 15 institutions from 12 European countries, to combine the skills of institutions specialised in various fields. The Consortium is led by the French National Museum of Natural History, legal contractor of the EEA for a second period of three years (1998 - 2000) and host the ETC/NC Core Team. The French Ministry of Land Planning and Environment, strongly committed since the beginning of ETC/CN, provides sustained additional financial support. Furthermore, the Museum and particularly the Institute for the Ecology and the Biodiversity Management (IEGB), is the French National Reference Centre for the conservation on nature.

Introduction

The Map Projections Workshop was organised by EuroGeographics following a request from the Joint Research Centre of the European Commission. Its objective, to be achieved by discussion amongst leading experts from the field of European geodesy and GI, was to examine the options and issues concerning suitable map projections for spatial data for use by the Commission in its activities. The Workshop took as the European Commission's area of interest the current 15 member states, plus European Free Trade Association and the 13 current candidate countries.

The Workshop followed the similarly organised "Workshop on Spatial Reference Systems for Europe" of November 1999, and dealt with issues that could not have been addressed then. While unanimity was easily reached for the 1999 conclusions (basically: geographic ellipsoidal coordinates in ETRS89 - see the full proceedings¹), this second Workshop had much more difficulties to reach a consensus.

The main reason is that, while a unique Spatial Reference System is nearly totally scale and application independent, this is not the case with Map Projections. The Workshop started with the users expressing nearly irreconcilable requirements and constraints, and conflicting suggestions for a unique Projection. Debates have been very rich, and convergence was gradually achieved on a set of recommendations, but also on the need for further work, from the experts (to clarify some technical issues and definitions) and from the European Commission (to continue the actions in the effect of harmonising the usage of coordinates systems with the GI users within the Commission and without).

The work done at the Workshop on 14-15 December 2000 has continued through the generous contributions of the participants, and in particular of the 'editing committee' (Alessandro Annoni, Iain Greenway, Claude Luzet) and of

¹ Annoni, A.; Luzet, C. (Eds.):
Spatial Reference Systems
for Europe; Workshop 29-30
November 1999, Marne - La
Vallée; Proceedings and
Recommendations;
European Commission EUR
19575 EN, 2000.

the ‘expert committee’ (Christoph Brandenberger, Johannes Ihde, Roger Lott, Lysandros Tsoulos, Stefan A. Voser, etc...). In addition supplemental input came from other experts and from the EUREF working group ‘transformation’ (Josef Adam, Bjorn Geirr Harsson, Johannes Ihde, Joao Torres and Erich Gubler).

However convergent the expert conclusions have been, it appears that there were still options open, providing nearly equivalent solutions. Between them the choice has been done taking into account existing solutions and current preferences of several Services of the European Commission and of the European Agencies (main users of pan-european data).

The Workshop reviewed the recommendations of the November 1999 Workshop on Spatial Reference Systems. It noted that ETRS89² is recognised by the scientific community as the most appropriate European geodetic datum to be adopted. It is defined to 1cm accuracy, and is consistent with the global ITRS³. ETRS89 is now available due to the creation of the EUREF⁴ permanent GPS station network and the validated EUREF observations. It is already part of the legal framework of some EU member states. The Workshop also noted that the IAG⁵ sub-commission for Europe (EUREF) has defined a European vertical datum based on the EUVN⁶/UELN⁷ initiative. The datum is named the EVRS⁸ and is realised by the EVRF2000.

The Workshop reaffirms the recommendations of the November 1999 Workshop that the European Commission:

- Adopts ETRS89 as the geodetic datum for the geo-referenced coordinates of its own data, and includes ETRS89 in the future specifications of products to be delivered to the EC, within projects, contracts, etc,
- As far as possible, uses ellipsoidal coordinates (geodetic latitude, geodetic longitude, and if appropriate ellipsoidal height) related to ETRS89, with the underlying GRS80 ellipsoid, for expressing and storing positions [ETRS89⁹].

The Workshop further recommends that the European Commission:

- Adopts the EVRF2000 now available for expressing practical heights (gravity-related) and includes EVRF2000 in the future specifications of products to be delivered to the EC, within projects, contracts,
- Continues to promote the wider use of ETRS89 and EVRF2000 within all member states and internationally, by appropriate means (recommendations, official statement,...).

The Workshop targeted the needs of the European Commission related to:

- Vector data (thematic polygons, topographic etc);
- Raster data existing as both gridded information, and as images/photographs (orthorectified or otherwise).

and considered the requirements of:

- Storage (in a centralised database or in distributed databases);
- Cartometry (for instance, computing distance, area, etc);
- Displaying (on screen, paper maps, atlases etc).

The Workshop concluded that there would be significant cost resulting from the data conversion needed when adopting any new map projection system, but that changes were necessary due to the inadequacy for pan-European purposes of existing map projection systems in use within the EC.

The Workshop considered that the initial conversion costs would be more than offset by the benefits received when an adequate system had been implemented.

European coordinate reference systems

European needs

² ETRS: European Terrestrial Reference System.

³ ITRS: IERS Terrestrial Reference System (IERS: International Earth Rotation Service).

⁴ EUREF: European Reference Frame.

⁵ IAG: International Association of Geodesy.

⁶ EUVN: European Vertical Reference Network.

⁷ UELN: United European Levelling Network.

⁸ EVRS: European Vertical Reference System.

⁹ See details in chapter “ETRS89 ellipsoidal coordinate reference system [ETRS89]”.

The Workshop noted the need of coordinate reference systems for pan-European applications for many statistical purposes (in which area remains true) or for purposes such as topographic mapping (where angles or shapes should be maintained). These needs cannot be met through usage of the ETRS89 ellipsoidal coordinate reference system alone, and some map projections are required to supplement the ellipsoidal system (because the mapping of the ellipsoid cannot be achieved without distortion, and that it is impossible to satisfy the maintenance of area, shape and distance, through a single projection).

For the purposes of evaluating projection distortion, the area of interest was taken to be a primary area equating to the EU15 except for outlying islands in the Atlantic (Madeira, Canaries, etc) (“EU15”), and a secondary area covering the current EU15 including Atlantic islands plus the EFTAS¹⁰ countries and the 13 current EU candidate members (“EU15 + EFTA + CEC13”).

In addition, the secondary area was extended eastwards to the Ural Mountains “Geographic Europe”. The primary area is bounded by parallels of 71°N and 34°N and meridians of 11°W and 32°E (a range of 37° latitude and 43° longitude) whilst the secondary area is bounded by parallels of 82°N and 27°N and meridians of 32°W and 45°E (a range of 55° latitude and 77° longitude). The eastern boundary of the secondary area extension is 70°E, extending the longitude range to 102°. See Figure 1. The centre of the area of interest was taken to be 53°N, 10°E.

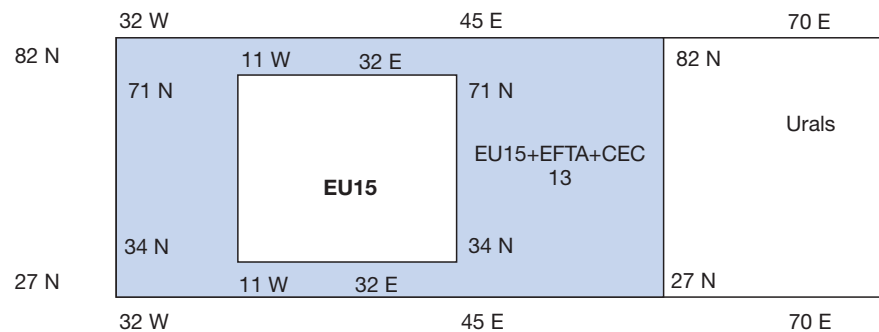

Figure 1:
the area of interest.

Map projections to be used for European purposes

The Workshop recommends that the European Commission:

- Uses for statistical analysis and display a ETRS89 Lambert Azimuthal Equal Area coordinate reference system of 2001 [ETRS -LAEA¹¹], that is specified by ETRS89 as datum and the Lambert Azimuthal Equal Area map projection.
- Uses for conformal pan-European mapping at scales smaller or equal to 1:500,000 ETRS89 Lambert Conic Conformal coordinate reference system of 2001 [ETRS -LCC¹²] that is specified by ETRS89 as datum and the Lambert Conic Conformal (2SP) map projection.
- Uses for conformal pan-European mapping at scales larger than 1:500,000 ETRS89 Transverse Mercator coordinate reference systems [ETRS-TMzn¹³], that are specified by ETRS89 as datum and the Transverse Mercator map projection.
- Helps in developing technical details of the recommended projections after the workshop (establishing links with existing working groups, carrying out further studies, asking for expert advice to define, validate and confirm the proposed choices).
- Maintains the ETRS-TMzn, ETRS-LAEA and ETRS-LCC as its conventional standards for an extended period, in order to provide stability and confidence for data providers and users.
- Stimulates the use, by preference, of one of the above defined map projections for screen displays or prints.

¹⁰ European Free Trade Association.

¹¹ See details in chapter “ETRS89 lambert azimuthal equal area coordinate reference system [ETRS-LAEA]”.

¹² See details in chapter “ETRS89 Lambert conformal conic coordinate reference system [ETRS-LCC]”.

¹³ See details in chapter “ETRS89 transverse mercator coordinate reference system [ETRS-TMzn]”.

The Workshop recognised that both the European conventional coordinate reference systems, and the current national (and local) coordinate reference systems will continue to coexist for many years to come.

The Workshop noted that commonly encountered terms such as 'UTM zone 32N' without reference to the associated geodetic datum were ambiguous.

It also noted that numerous existing procedures allow transformation or conversion of coordinates from one system to another. Some of these procedures are freely available, some are embedded in commercial software, yet many are reserved for internal use and not publicly distributed.

There is a multitude of user-defined relationships in use. There is an urgent EC business need to implement a single set of officially recognised transformations.

The Workshop recommends to NMAs and EuroGeographics:

- To use the European conventional coordinate reference systems wherever possible or to provide definitions and parameters for transformations and conversions;
- To place in the public domain as soon as possible transformation parameters and formulae between national coordinate reference systems and European conventional coordinate reference systems, providing an accuracy of the order of 1~2m.
- To make widely known the availability of the information and to indicate the availability of more accurate transformations (with the achievable accuracy and the official source of information);
- To continue the process of educating the users of geographic information in the complex issues associated with coordinate reference systems, map projections, transformations and conversions, including working with software and system suppliers to enable 'on the fly' transformations between commonly-used coordinate reference systems.

The Workshop further recommends to the European Commission:

- To take strong action to support the work of EUREF and EuroGeographics in collecting and making publicly available all necessary authoritative information.
- To be aware that some widely used (non validated) collections already exist (maybe useful both for temporary 'non authoritative' solutions and for local uses).
- To continue to support EuroGeographics in encouraging National Mapping Agencies to adopt European conventional coordinate reference systems wherever possible or to develop national coordinate reference systems which are compatible with the European conventional coordinate reference systems.

In general, the Workshop recommends to EC, NMAs, EuroGeographics and other data providers/users:

- To always identify coordinate reference systems in the format required by International Standard 19111 (which currently exists as a Draft International Standard).

The Workshop recommends to the European Commission to further investigate (in the future):

- the possibility to define a single indexing system for statistical purposes, seeking a multi-resolution solution for an equal area gridding system;

- the problems related to resampling when transferring raster data between coordinate reference systems;
- the problems related to the use of data expressed according to European conventional coordinate reference systems in a global context.

Results dissemination

The Workshop recommends to the European Commission:

- That the results of the meeting and follow-up activities are widely communicated to the GI Community including industry, standards authorities, and potential users. It is also important to stimulate feedback in order to ensure that EC and other users needs are harmonised.

The EC requirements in terms of Projection Systems

A. Annoni, J. Delincé, A. Wirthmann, C. Steenmans

Europe is a patchwork of several countries with different traditions in terms of their geographic choices. In December 1999 in a first workshop, organised by JRC and MEGRIN, the need of a common Spatial Reference System for Europe was discussed as first step to ensure that geographic data are compatible across Europe and the workshop established that a suitable candidate as European Spatial Reference System exists: ETRS89. The European Commission is now facing the problem of cartographic representation and grid storage of pan-European geographic data at different levels of precision. The area of interest is the current 15 member states and the 13 current candidate countries. This paper shows some of the needs of the European Commission that should be supported by the future European Conventional Reference Systems.

Introduction

Projected data are used in different contexts and for different uses within projects/initiative coordinated by the European Commission:

- sampling (for example: data collection for statistical purposes),
- storing (picture like satellite images, aerial orthophotos,..., but also raster representations of vector data like digital terrain models, slopes, land cover,...),
- cartographic display (both on paper maps or on screen),
- measurements (measure of linear features, measure of areas,...). Overlays and measurements of areas and lengths should provide true areas and distances on this scale,
- spatial analysis (integrated assessment using different spatial layers),
- localisation (projected data are used to localise object on the ground).

Use of projected data

A general problem of the European Commission concerns the integration and harmonisation of data projected in different national systems.

Data are received according to national projections often ambiguously documented or produced with software using different “not officially certified” parameters. It makes so difficult to re-project to a common European system and to minimize the distortion effects.

In addition, other aspects should be considered:

- There is a broad spectrum of European projects/initiatives/directives that can be classified in 4 broad categories:
 - initiatives requiring the setting-up of National systems (i.e. LPIS¹⁴, Olive tree Registers, ESDP¹⁵,...) without significant European restriction,
 - initiatives both requiring the setting up of national systems and the integration in a European system (e.g. GISxNatura2000, I&CLC2000),
 - projects requiring a European remote access to national distributed data bases
 - projects requiring identical standards at National and European level.
- The required accuracy and scale is ranging from very precise data (i.e. LUCAS 1-2,5 m using projected data at 1:10,000 scale) to global (i.e. FISIS¹⁶ working at 1:20,000,000 scale),
- Data to be used are
 - already available in the European Commission Reference data base (GISCO)
 - should be harmonized from existing at national level, and
 - some of them collected/created since scratch.
- Precise technical specifications are needed both for data collection/creation and for conversion of existing data. The specifications/recommendations should foresee a stepwise approach to identify current solutions and to suggest a long term strategy for quality improvement (in this sense the limitations of current GIS sw and their future evolution should be taken into account).

¹⁴ Land Parcel Identification System.

¹⁵ European Spatial Development Perspective.

¹⁶ Fishery Information System.

New trend in EU policies related to geographic information

EU policies are evolving, in particular the policies having a strong spatial dimension. As mentioned in the recent JRC study “The Spatial Impact of EU policies and the need for a European GI framework” there is an increasing shift towards integrated policy development and assessment, the emergence of spatial planning as the framework for such integration, and new requirement for more geographically targeted needs assessment. In this context geographic information is crucial (there is a significant increase of detailed geographic information across the Union as a result of the new policy requirements). This information needs to be managed, analysed, and made public. The need to integrate policy means that information also needs to be integrated across policy domains, and areas of intervention.

Geographic information is increasingly important therefore not just for its thematic attribute content but also as the framework to integrate data from these different domains, and areas. So on there is a need to increase the flow of disaggregated data from the local level to the European in all the policy domains. There is a need to develop new datasets and to share knowledge of who has what data, and how it can be accessed (this is increasingly crucial as there is a real danger of multiple duplication of data collection to respond to different policies). Finally there is a need to implement a agreed framework for GI in Europe, including common reference system, projections, homogeneous territorial and statistical units (including actions for increased data comparability and interoperability).

There is a lack of harmonized data at European level. To address these limitations we are starting to see a major shift in emphasis towards a more decentralized approach to data management, leaving the data at the level at which it can be more easily collected and updated, with an attempt to integrate more cohesively information flows from local to global and vice-versa. Assuring access to such geographic and environmental data becomes in this scheme an absolute pre-requisite. Hence the new initiative of DG Environment for a Infrastructure for Spatial Information in Europe (INSPIRE¹⁷).

Examples of European requirements

The following list of European initiatives (projects, directives, regulations,...) is not hesaustive but could be useful to understand European Commission needs related to map projections:

- Statistical Grids,
- LUCAS - Land Use/Cover Area Frame Statistical Survey,
- Water directives,
- NATURA 2000,
- IMAGE 2000 and CORINE Land Cover 2000,
- Agro-Environmental Indicators,
- Trans-European-Networks,
- LPIS-Land Parcel Identification System.

Statistical Grids

In the Working Group meeting held at Eurostat in Luxembourg 20-21 October 1999, some of the National Statistical Institutes (NSIs) expressed their interest and need for a common coordinate reference system to be used when statistical data are presented on regular grids for more than one country. The problems are related both to the collection of statistical information and to the way to analyse and display statistical data.

The first aspect applies in particular to countries, which have georeferenced registers on population, enterprises, and buildings as the base for compilation of statistical data (the Nordic countries, Switzerland, the Netherlands) but it is always present when we compare census or reporting units of different sizes (i.e. the different levels of national territorial units NUTs).

¹⁷ www.ec-gis.org/inspire.

Grids are also used to analyse or display statistical information. A recent study of JRC committed by GISCO show the advantage of disaggregating data related to Population (available at NUT5 – commune level) using CORINE Land Cover raster data to produce more precise population density maps.

An example of cross-border rectifications of statistical data based on grids was made in 1997 by the statistical offices in Finland and Sweden (reported by Tilastokeskus in Research reports 221 “Differences in the Spatial Structure of the Population between Finland and Sweden in 1995”). The input data were delivered according to the national coordinate systems in each country. Since the Finnish grid is based on the International 1909 datum while the Swedish grid is based on the Bessel 1841 ellipsoid, cumbersome recalculations had to be done in order to fit the two data sets where the two countries share a land border. Had a European Reference System been put in place, it would have spared this project a lot of efforts for the calculation of the grids.

We are so looking for a solution to represent EU15 and PanEurope on one map. The area of the grid-cells should be equal. The linear distortion and the distortion of the shape of the cells should be minimal. The demands for spatial accuracy on mapping are lower than for calculating the grids. It should be possible to reproject grids with different projection to one projection system in order to overlay and overlay both.

Data concerned are stored in statistical databases, geo-reference is given through a administrative unit identifier (i.e. NUT) or a geographic object (i.e. river, road,...). The precision as well as the size of the smallest grid are ranging from applications at NUT5 level (communes) until applications at European scale. Existing examples use grids with a range of cells from 1x1 km² to 50x50 km².

The continued application of aerial survey and remote sensing techniques for the collection and analysis of agricultural statistics over the period 1999-2003 is the matter of Decision 1445/2000/EC of the European Parliament and Council on the 22nd May 2000. The decision states that “*There is an especially felt need for information on land use and on the condition of crops in the context of new developments in the common agricultural policy and with a view to enlargement, in particular for the analysis of interactions between agriculture, the environment and the countryside*”.

Land Use/Cover
Area Frame
Statistical Survey
(LUCAS)

Art 1 of the Decision states:

- Over a five-year period starting on 1th January 1999, an aerial-survey project shall be implemented at Community level in agricultural statistics. The use of remote-sensing shall also be continued, in particular with the agrometeorological system being made operational.
- Taking into account data already collected by the Member States, the measures referred to in paragraph 1 shall be designed, at Community level and if possible in areas of interest to the Community, more specifically to:
 - collect data needed to implement and monitor the common agricultural policy and analyse interactions between agriculture, the environment and the countryside,
 - provide estimates of the areas under the principal crops,
 - ensure that the condition of crops is monitored until harvesting, so as to enable early estimates of yields and production to be made.

On the base of this decision, the Directorate General Agriculture and Eurostat launched the LUCAS project: Land Use/Cover Area Frame Statistical Survey. The objectives are:

- To realize a point area frame (area frame means that the observation units are territorial subdivisions instead of agricultural holdings) to collect the land use/cover information, in particular in its broad sense agricultural component.

- To establish a common sampling base that interested member states can use to obtain representative data at national/regional level by increase of the sampling rate, respecting the general LUCAS approach.
- To test a harmonised approach, when possible with the voluntary participation of the national statistical services, limiting the survey workload imposed to the farmers and offering a pertinent solution for the candidate Countries.
- To define a homogeneous survey methodology in terms of sampling plan, nomenclature, data collection and treatment.
- To extend the scope of the survey covering the usual agricultural domain but also the aspects linked with environment, multifunctionality, landscape and sustainable development.

As final products of LUCAS we will have Land Use and Land cover area estimates, evaluation of environmental characteristics (erosion, linear features, openness, noise, natural hazards) and digital photo collection on the segments. The methodology foresees around 10.000 segments will be distributed over EU15. A surveyor will collect the land information in April /May/June, and, possibly, will conduct a panel of farmer's interviews in October. The survey methodology will be detailed in technical dossiers (sampling, nomenclature, ground survey, data treatment) written by EUROSTAT. The field work should allow the land classification within around hundred categories and the measurement of around ten landscape characteristics. The survey, annual on the 2001-2003 period, will be composed of two phases so that in June the Land use/cover data will be derived and that, within the budget limits, the "farm" data could be available in November each year.

To carry out the survey large scale orthophotos (1-2 m of accuracy) are used for precise localisation in the field as well as GPS measurements. There is the need of sample selection at Member State level (regular grid) and precise location of the surveyor up to 1-2 meters. The use of one UTM projection grid per country with the WGS84 datum has been retained as solution. Problems to be addressed are the scale effect on the border of the grid in large countries like France and Spain.

The water directives

Directive 2000/60/EC of the 23rd October 2000 establishes a framework for Community action in the field of water policy. This Directive has a strong spatial impact as it defines river basins as the most appropriate spatial framework for a comprehensive approach to water protection. In this respect Art. 3 states that: "*Member States shall identify individual river basins lying within their national territory, and for the purpose of this Directive shall assign them to individual river basin districts*" (Art 3.1). Such basins will include not only surface waters but also ground-waters and coastal waters, assigned to the nearest or most appropriate river basin or district. Further, Art 3.4 states that for the achievement of the environmental objectives of this Directive, all programmes and measures are coordinated for the whole of the river basin, and that a competent authority is assigned the responsibility for the implementation of the Directive.

For each river basin, a management plan needs to be prepared within nine years from the entry into force of the Directive. The contents of these plans are detailed in the technical annexes of the Directive, which also states that the names of the main rivers within the river basin district together with a precise description of the boundaries of the river basin district should as far as possible be available for introduction into a geographic information system (GIS) and/or the geographic information system of the Commission (GISCO) (Annex 1 of the Directive). The data collected to characterize each surface

water body has also to be submitted to the Commission on maps in GIS format (Annex 2 of the Directive), including data on environmental pressures in the basin, and impacts. For ground-waters, in addition to location and boundaries, the data includes pressure points related to pollution, geological data, and a review of the impact of human activities including land-use in the catchment from which the groundwater body receives its recharge, including pollutant inputs (Annex 2 of the Directive).

The Water Directive outlined above incorporates and extends many of the requirements already required by the Directive 91/676/EEC of the 12 December 1991 concerning the protection of waters against pollution caused by nitrates from agricultural sources. This Directive already required Member States to identify on maps the waters (both surface and ground-water) affected by pollution, and the location of designated vulnerable zones for which an action programme of remedial action is required. The new Water Directive includes pollution by nitrates into its framework as part of the combined approach for point and diffuse sources set out in it Art. 10. To apply this directive properly precise limits of Nitrate vulnerable zones have to be digitized. Additionally the Directive foresees monitoring points that are related to surface waters.

In both Directives geographic data are coming from the member states in different projections and reference systems. The hydrographic network and a digital map of drainage basins are used as a reference layer for the monitoring points. We need to transform data in national project to a common projection system with appropriate accuracy. The coordinates of the monitoring points should be mappable on the river network and the drainage basin. The area size of the drainage basin has to be calculated as well as the length of the river network. Digital elevation models and hydrographic networks are used to derive drainage basins. The main problems in water monitoring and management is his trans-national/regional aspect (water quality is not respecting administrative boundaries) that require seamless data within Europe.

Natura2000 is the cornerstone of the EU Nature Conservation Policy, involving the creation of a network of sites designated at European level in order to protect rare and endangered species and natural habitats. The creation of this network requires the integration of existing designated sites with proposals from Member States in order to define a Community List of sites, which should be finalised by 2004.

Natura2000

Natura2000 has two basic data collections – the maps archive and the alphanumeric database. In contrast to the rigorous definition of information requirements for alphanumeric data, supported by detailed specifications and a comprehensive data entry application, the requirements for provision of GI are less exhaustive causing severe problems in integration of spatial data.

A priority activity (under development as DG ENV-JRC collaboration) is to integrate these two separate systems into a single spatial database (GISxNATURA2000). The Natura2000 alphanumeric database contains several elements of explicit spatial information (site centroid, area), as well as implicit spatial information (relationship to NUTS administrative regions, altitude, relationship to CORINE biotopes, relationship to other Natura2000 sites etc). Often, when the digital site boundaries (polygons) are analysed, anomalies are detected between these spatial data and the alphanumeric database.

Natura2000 boundaries are collected through National paper maps ranging in different scales and quality. Digital files are sometimes provided by they are not “official” documents. Harmonisation between regions and countries is required.

Additional data are required for advanced spatial analysis (buffering, ecological-corridors). Impact assessment is required for EU policies both at

regional/local scale (i.e. LIFE projects, structural funds, agri-environmental measures,...) and a national/European level (i.e. Interreg, Trans European Networks,...). Unfortunately the data needed for spatial analysis are not often available in the European Commission database (GISCO). The temporary access to distributed data bases could be considered a possible solution until a legislative framework to access distributed local/regional/national data (INSPIRE-Infrastructure for Spatial Information in Europe) or more detailed GI will be not available within the Commission.

IMAGE 2000 and CORINE Land Cover 2000

The interest and demand for using land cover as a basic layer for spatial analysis within integrated environmental assessment is strongly increasing in Europe at local, regional and continental level. To respond to these user needs, an update of the European CORINE Land Cover database (called CLC2000) providing European wide consistent information on land changes, has been initiated. Data will be collected from satellite images (called IMAGE2000) which need to be geo-referenced to a common reference system allowing easy conversion between national and European coordinate systems. CLC2000 is a joint project between EEA and the JRC.

More precisely IMAGE2000 concerns the creation of national and European orthorectified mosaic of satellite images (snap shot of Europe for year 2000), CLC2000 is related to the updating of the CORINE Land Cover data base and to the mapping of land cover changes in last decade. Both are considered a key step to provide new European reference layers at scale 1:100,000 for spatial analysis. Satellite images (pixels size 30x30 m, scale 1:100,000) that will be used for photo interpretation are produced both in national map projection and in a European coordinate reference system to be selected. National team will produce national land cover databases that will be integrated to produce a common European land cover data base (using geographical coordinated related to ETRS89).

The following products (grid based) are foreseen at European level:

- satellite mosaic for Europe (pixel size 30x30 m)
- two European land cover grids (grid size 100x100 m and 250x250 m)
- land cover statistics (grid size 1x1 km).

There are various problems related to the possible technical choices: guarantee the compatibility between national products (national orthorectified images, national land cover databases,...) and the European ones (satellite mosaic, CLC database, CLC raster data, European statistics,...) taking into account that images will be orthorectified using national systems but some common data (i.e. digital terrain model) will be used to maintain the same level of accuracy everywhere. A projection system should be used to store the satellite mosaic and the CLC raster data. It should be defined to reduce the costs of production for both national and European products.

Trans-European- Networks

Transport policy is a crucial element of the integration of the European territory. Article 129b of the 1994 Maastricht Treaty links the development of Trans-European Networks in the field of transport, energy, and communication to Art. 7a (free movement of goods, persons, and capital in the Single Market), and Art. 130a (promotion of economic and social cohesion). Decision (1692/96/EC) of the European Parliament and of the Council defines the Community guidelines for the development of the Trans-European Transport Networks (TETNs). The TETNs is one of the most ambitious programmes of the EU. The network is to be established from bottom-up planning in keeping with the subsidiarity principle. The spatial impacts of transport policies are multiple and often difficult to measure. Hence, monitoring and evaluating the impact of the TETNs has major requirements for spatially disaggregated data.

Even operating at NUTS2 level, that project demonstrates the complexity of modeling transport impact in the economic and social spheres due to data limitations. The needs for geographic information arising out of the EU transport policy are recognized in Decision 1999/126/EC defining the Community statistical programme. As stated: *“Implementing the common transport policy requires comprehensive, precise and rapid information on the functioning of the European transport system so that the policies and initiatives pursued can be assessed and the quality of transport systems improved through the development of integrated and competitive systems... The development of trans-European transport networks (TETNs) means that the work programme for this area must fulfill the requirements of precise and comparable information, improved collection methods and new concepts for analysing and presenting the data (for example geographic information systems)”*.

The European Commission has long recognised the imperative of improving transport infrastructure between the Union and Central Europe after five decades of neglect. There will not really be open borders and free movement of persons and goods unless the roads, railways, airports and ports in these countries are modernised. In 1996 the Commission set up a process of Transport Infrastructure Needs Assessment (TINA) to oversee and coordinate the development of an integrated transport network in 11 applicant countries. The idea is to coordinate infrastructure projects in these countries with those implemented in the EU, with a view to extending the Trans-European Transport Network to the new Member States in future.

The Directorate General Transport and Energy is setting up using a GIS system for modeling purposes. It shall be possible to model scenarios of traffic distributions and flows in Europe and their impact on the Trans European Traffic network. Additionally the DG intends to use the database as an alarm system for new traffic projects. It should be possible to envisage potential conflicts with e.g. environmental issues. At least it would be a big step forward to be able to make a first assessment of new traffic connections proposed by the Member states. To fulfill these requirements, the traffic lines have to be overlaid with other layers, measurements of lengths have to be calculated, and data with coordinates in national projection systems have to be converted. The DG is using road and rail network data. Basic requirement for the projection system to be selected is that the measure of lengths along the traffic lines should be true. It should be possible to convert data with coordinates from different projection systems. It should be noticed that the extent of the area could be very large (EU15+EU13 candidate countries) but the precision required is corresponding to the work to be done at very small scale (1:1,000,000).

The requirements for an Integrated Administration and Control System (IACS) for certain Community aid schemes are set out in the Council Regulation no. 1593/2000. The Regulation states inter-alia that: *“In view of the difficulties encountered when carrying out administrative checks on areas declared, and in particular the costs and time involved in clearing up anomalies in declarations and in view of experience in a number of Member States which have created a special parcel identification system and progress in digital orthoimagery and geographical information systems, provision should be made for the introduction of computerized geographical information system techniques for the identification of agricultural parcels”*. The new system (LPIS) is to include a parcel identification system “on the basis of maps or land registry documents or other cartographic references. Use shall be made of computerised geographical information system techniques including preferably aerial or spatial orthoimagery, with an homogenous standard guaranteeing accuracy at least equivalent to cartography at a scale of 1:10,000”.

Integrated Administration and Control System (IACS)

Detailed geographically-based control systems are also in force in respect to the production and marketing of olive oil. In this area, EC Regulation 1638/98 states that: *“Notwithstanding Regulation (EEC) No 154/75, work on the olive cultivation register during the 1998/99 to 2000/01 marketing years shall focus on the creation, updating and utilisation of a geographic information system (GIS). The GIS shall be created using the data from the olive cultivation register. Additional data shall be supplied from the crop declarations attached to the aid applications. The information in the GIS shall be geographically situated using computerised aerial photographs. Member States shall verify that the information in the crop declarations corresponds to the information in the GIS. If this information does not correspond, the Member State shall carry out verifications and on-the-spot checks”*.

The importance of establishing a GIS-based register for olive trees, is reinforced in COM(2000)855... which identifies a number of problems stills affecting the monitoring and control systems in this field. For this reason, the Com states that: *“The Commission is proposing that the Council should specify as of now that the future aid scheme will be controlled by means of an olive cultivation GIS that is fully operational. With effect from 1th November 2003, aid would thus be granted only for olive trees or olive oil from olive groves that are covered by an olive cultivation GIS certified as having been completed”*.

The current strategy of the European Commission is to leave Member States free of the choice of the map projections they use as long as their choice is reasonable. These systems are mainly used as basis for agricultural declarations. There is no apparent need (for DG AGRI) to integrate in a unique European system. Controls are carried out using national projected data and systems.

Agri-Environmental indicators

Through the 1990s there has been an increasing recognition of the importance of the integrating environmental objectives in all EU policies, and the 1997 Amsterdam Treaty endorsed sustainable development as one of the core objectives of the Union. COM(1999)22 “Directions towards sustainable agriculture” sets the CAP within the broader context of enlargement and Agenda2000, and is designed to achieve necessary structural adjustments in principal market regimes, and a strong rural development policy, becoming a second pillar of the CAP. The reform has five main objectives: to increase competitiveness; to assure food safety and food quality; to maintain a fair standard of living for the agricultural community and stabilise farm incomes; to better integrate environmental goals into the CAP and to develop alternative job and income opportunities for farmers and their families.

In particular, the reform seeks to balance the economic needs of farmers, with broader environmental objectives, including the protection and enhancement of rural landscapes, and with social objectives, including the viability of rural communities. Among the range of measures introduced, are the development of integrated programmes for the sustainable development of rural areas, and the application of targeted agri-environment measures offering payments to farmers who, on a voluntary and contractual basis, provide environmental services to protect the environment and maintain the countryside.

Landscapes are often the result of a complex and gradual moulding by human activity. The nature of its green cover is often seen as the main element that describes a landscape, reflecting natural conditions and the history of human intervention. The objective of the landscape analysis is to assess landscape diversity and to investigate the role of agriculture and agricultural practices as driving forces behind land shaping processes. The CORINE Land Cover dataset has been tested for its ability to provide a systematic and coherent picture of

spatial diversity of the rural landscape. GIS is used to calculate various indices reflecting land cover diversity. Some indices calculate area sizes of classes which are compared with the sizes of other classes or with the total area. Other indices compare the lengths of common boundaries of one class with other classes. As the indices are calculated using area sizes and length measurements, a selected projection has to ensure the true size of lengths and areas.

The importance of developing environmental indicators is emphasized in COM(1999)22 and in the Court of Auditors SPECIAL REPORT No 4/2000, which identified some currently significant gaps in agri-environmental knowledge. With these considerations in mind, COM(2000)20 Indicators for the Integration of Environmental Concerns into the Common Agricultural Policy, states that: *“At present, a partial set of indicators can be established to monitor the integration of environmental concerns into the CAP... In principle, many of these indicators could be operational in the short to medium term, dependent on the adequate collection of data at a sub-national level... A number of key actions need to be undertaken to ensure that the potential of indicators is fully exploited. These involve improving existing indicators as well as extending the set to fully cover sustainable development, improving information collection capacities...”*. Particular emphasis is given to the need for site-specific indicators: *“For the monitoring of rural policies and agri-environmental programmes, indicators have to reflect site-specific features and programme criteria in order to be meaningful. Less site-specific indicators, which are more readily available, tell little about effects in local areas. Indeed, they may fail to disclose significant developments at a local or regional level... A site-specific approach is necessary”*.

COM 2001(144) builds on the COM 2000(20) outlined above, and focuses on the data needed to compile the indicators there defined. The COM identifies 35 indicators covering the DPSIR framework (Drivers, Pressures, State, Impact, Response). The main sources available for the development of these 35 indicators include:

- statistical data available in the European Statistical System, and relating to livestock and crops, and the environment (environment statistics questionnaire),
- forestry statistics envisaged by Council Resolution 1999/C 56/01,
- the Farm Structure Survey carried out every 2-3 years since 1966/67 across the EU,
- the Land Use/Cover Area Frame Statistical Survey (LUCAS) Project which will give detailed geo-referenced information from 2001,
- the Farm Accountancy Data Network, based on a sample of 60,000 holdings,
- the Integrated Administrative and Control System (IACS),
- the Rural Development Programme, which requires many indicators common to the ones envisaged in this COM, although they will need to be supplemented with ancillary contextual information.

Although several data sources exist that enable the creation of the indicators identified, it is important to note that in its conclusions, the COM states that *“...the use of administrative data represents the most cost effective solution for the calculation of a number of indicators”* (pag. 19). This data is either generated as a by-product of Community regulatory procedures, but often is not available to the Commission’s services, or is generated at the national and local level, but has restricted access. Twelve of the 35 indicators proposed fall under this category for which access is a major issue, and therefore are flagged as potentially requiring new Regulations to be made available.

The various needs of the European programmes can not be satisfied by a single projection system. The use of projections in modern cartography is not geared to

Conclusions

the present needs. Finding a good projection still causes the map maker a good deal of time and trouble. Information on maps, regarding map projection applied, is poor, incomplete and seldom appropriate for calculations. Some really innovative approaches (e.g. fractal projection systems) or the approach proposed by Mekenkamp during the Map Projection workshop could in the future help to solve the problems but they are not supported by current GIS. We face also the problem of wrong projections formulas in systems widely diffused on the market or lack of knowledge about the right parameters. Some interesting initiatives like Mapref of Stefan A. Voser are mainly based on voluntary efforts and they can not fully solve the problem related to liability and officiality of the parameters to be used. Without the insurance that all data providers are using the correct formulas and documenting in a standard and not ambiguous way the projection systems they used it will be impossible to guarantee the interoperability of the data.

Map Projections for the Layman - *Stefan A. Voser*

The morphological shape of the Earth as well as the coverage of the Earth surface are geometrically very complex and not easy to describe. A modern form for describing the Earth surface and the geographic situation on it are topographic maps and more generically geographic or thematic maps as well as their functional extension: digital geodata. One of the basic concepts for describing geographic positions are coordinates and their underlying coordinate reference systems (CRS). Various coordinate reference systems exist in which a geographic location may be described mathematically by coordinates. These systems vary in type, underlying concept and method as well as their instantiation. In each system, the position gets its own coordinate values. These values may differ in a conceptual, mathematical and numerical sense, but represent the same geographic position.

When collecting data stored in different coordinate reference systems, each CRS definition must be known together with its geometric relationship to a standard system. Only then it is possible to transfer all data into a standard coordinate reference system.

There exist several mathematical concepts to describe geographic positions by coordinates. For the following discussion, only two concepts of coordinate reference systems will be mentioned (Figure 2):

- geographic coordinates on mathematical (geodetic) Earth models
- “flattened” coordinates in the plane of a map projection.

Geodetic reference systems are used for describing the figure of the Earth and positions on it: *ellipsoids* (and the *sphere*) are used for describing the horizontal position, whereas *geoids* and other gravity related models are the main reference systems for the elevation. Geodetic reference systems have a *datum*, describing the position and orientation of the model in relation to the Earth and its surface. For the concepts of geodetic reference systems see e.g. [Annoni/Luzet 2000 p14f, p50f, Voser 2000].

Map projections are used to map the curved surface of an ellipsoid onto a plane. They have various characteristics, e.g. mathematical properties as different metric deformations, or they are validated for specific geographical extent etc.

For a long time, coordinate reference systems were only considered by specialists in geodesy and cartography, but since Geographic Information Systems (GIS), the Global Positioning System (GPS) as well as Remote Sensing have a rapidly growing amount of users, these concepts become more and more important: if these concepts and instantiations are not correctly considered, this may result in positional errors of hundreds of meters or up to kilometres or more.

Map projections are used to map the surface of a mathematical Earth model like a sphere or ellipsoid onto a plane based on geometrical or mathematical rules, principles or constraints.

Map projections have *advantages* for calculating geometric properties of spatial entities compared to the calculations of these properties on a curved Earth model. In the plane of the map projection, the calculation of distances, angles, directions and areas may be made based on the rules of classical geometry (Euclidean geometry). On the other hand, the *disadvantages* of map projections are their geometric distortions which depend on the position together with the projection method, its instantiation and implementation. This results in the fact that it is not possible to map from a curved surface like a sphere or spheroid onto a plane without distortions.

The analysis of the deformations is done by applying principles of differential geometry: the laws of surface theory. There, its first fundamental treats the geometric invariants (metrics on surfaces). Thereby, the rules to describe lengths, angles, areas are derived on the Gaussian fundamentals.

From the Earth surface to its representation on a Map

Flattening the Earth

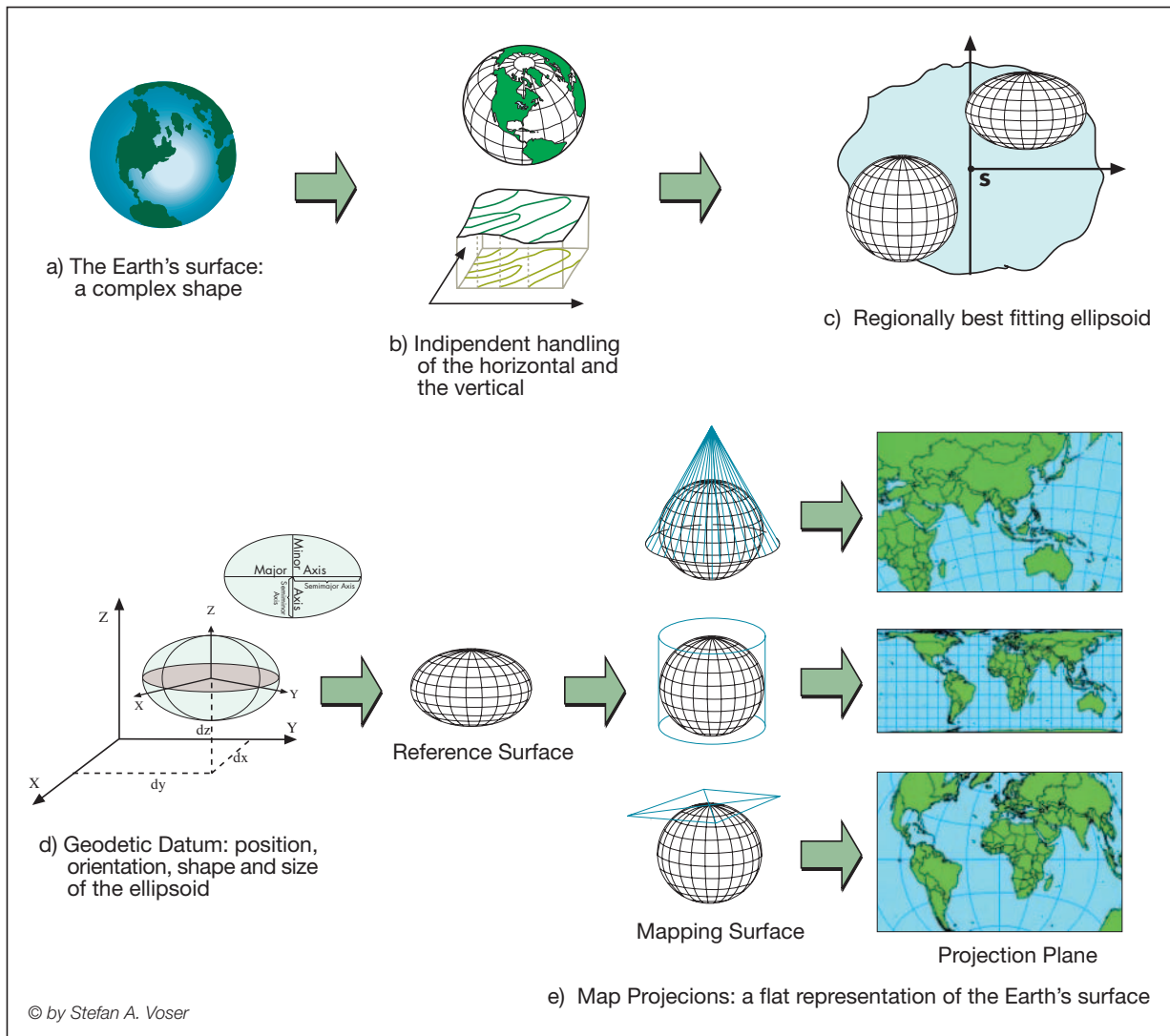

Figure 2:
From the earth surface onto the plane of a map projection.

The analysis of these geometric properties says, it is not possible to map from the surface of a sphere or ellipsoid onto a plane without distortion. Generically, angles, areas and length are distorted. But there exist ways to control the mentioned deformations in an infinitesimal matter.

Because of these distortions, map projections cover a wide field in mathematical cartography, or moreover, in geomatics. Several different types of map projections are known, and already the Ancient Greeks dealt this topic.

There exist various ways to classify map projections:

- the nature of the *mapping surface* (extrinsics of geometry)
- the *distortion* properties (intrinsic of geometry)
- the *geographic use* and extent
- other systematics (visual, mathematical properties...; not discussed below)

In the application, there exist much more individual instances of coordinate reference systems of type map projection. They vary not only in distortion properties, but also in their parameters as well as their method implementations. Important to know when working with map projections is the underlying Earth model and its geodetic datum.

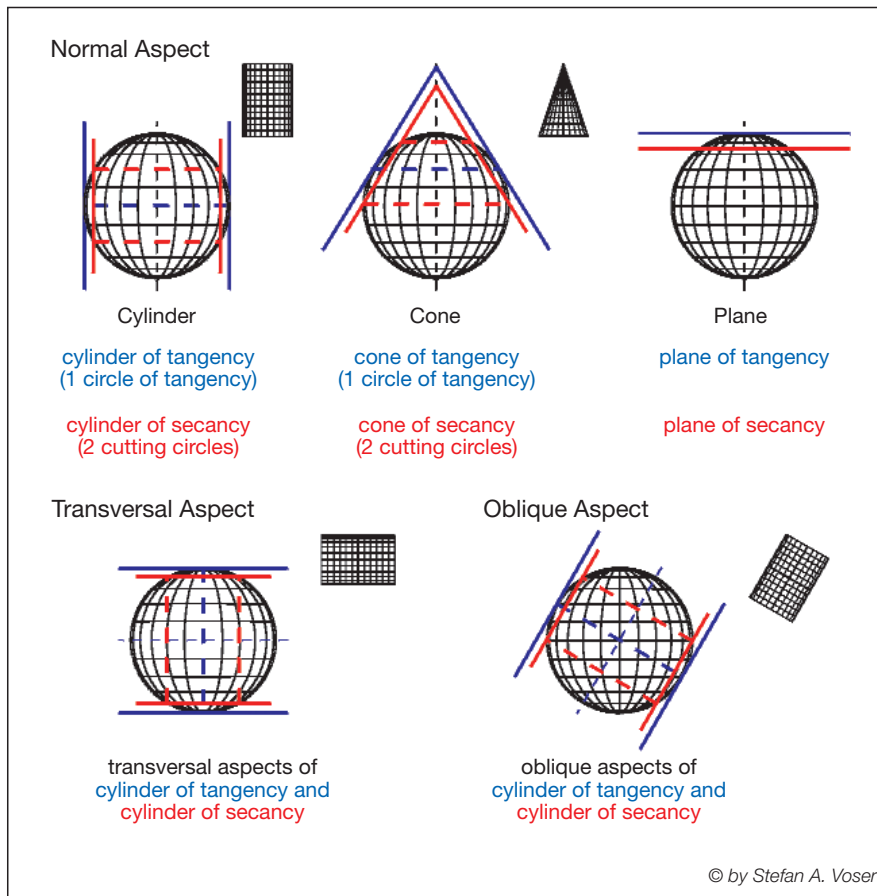

Figure 3: The mapping surface, their aspects and coincidence.

As already declared, a planar representation of the Earth has deformations compared to its shape on the Earth surface. These deformations depend on its position and the nature and specification of the map projection instance. One way to minimise the deformation properties is to use an appropriate mapping surface like a cylinder, cone or horizontal plane and its aspect (alignment) as well as its coincidence with the Earth model. These characteristics are called the geometric extrinsics of the mapping surface (see also Figure 3): nature, aspect and coincidence.

Mapping Surfaces

The nature of the *mapping surface*:

- cylinder
- cone
- plane
- polysuperficiality (a continuous system of mapping surfaces).

These mapping surfaces may be *aligned* in different ways. The name of its aspect is given based on the orientation of the axis of the mapping surface with the axis of the Earth. In literature, also other terms are used (see e.g. [Goussinsky 1951, Lee 1944, Richardus/Alder 1974, Snyder 1987]):

- *normal* or *direct* aspect (axis parallel to the Earth axis)
- *transversal* aspect (axis parallel to the equator plane)
- *oblique* aspect (axis with any direction).

The third extrinsic category is the *coincidence* (the “contact”) of the mapping surface with the underlying Earth model:

- *tangency* (“touching”)
- *secancy* (“intersecting”).

Figure 4:
Tissot's Indicatrix.

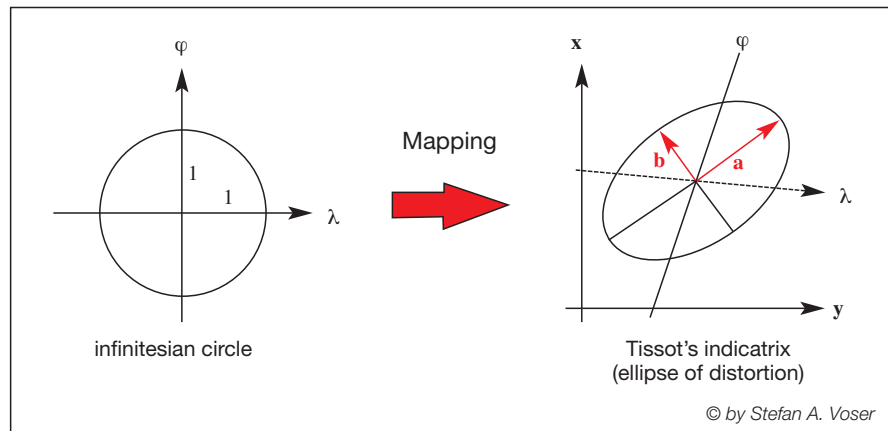

Distortion Properties of Map Projections

As it is not possible to map from the earth surface to a plane without distortions (intrinsic of geometry), a lot of effort has already been done to analyse the distortion properties. The distortions depend on the mapping surface, its aspect and other mathematical or geometrical properties of map projections and are a function of the position. Even though, a specific property may be found which is equal for each position on the projection. In fact, many projections were constructed by restrictions on the distortions. The methods therefore are given by the surface theory. The following metric distortions may be given, but the first three properties exclude each other:

- *conformity* or *orthomorphism* (locally no angular distortion),
- *equivalency* or *authalicity* (locally equal-area properties),
- *partially equidistant* (specific lines as meridians are mapped with true length),
- *compromise* or *error minimised* (restrictions to all distortion properties).

The mathematical instrument to calculate distortions is based on the Tissot Indicatrix: the first order approximation of the mapped shape of an infinitesimal small circle on the origin surface is a ellipse, the Tissot Indicatrix (Figure 4). The analysis of this ellipse defines the distortion properties, using the semi major axis a and the semi minor axis b of the ellipse:

- *conformity*: for all points, T.I. is a circle ($a=b$)
- *equivalency*: for all points, the T.I has the same area ($a*b=const$)
- *partially equidistant* (specific lines are mapped with same length: $l=const$)

The use of Map Projections

The amount of different types and variations of map projections existing nowadays has grown to more than 200. (See therefor e.g. Bugayevskiy 1995, Richardus/Adler 1974, Snyder 1987). They vary in properties and usage:

- for the display of *topographic data* mainly conformal projections are used,
- for *thematic and statistical data* very often *equivalent* projections are used, or also *equidistant*,
- for *navigation*, *conformal* projections are used. A very often used projection therefor is/was the Mercator projection which also keeps the lines of the same azimuth (loxodrom) as straight lines,
- for very small scale maps in publications and for wall maps, often also composed projections are used.

An overview of popular map projections is given in the table 1. The main classification is made based on their deformation properties, and their mapping surface. Their main use is given.

Distortion property	Mapping surface	Aspect	Projections	Area of Use (Extent)
<i>conformal</i>	cylinder	normal	Mercator	World equator regions: east-west extent
		transverse	UTM (Universal Transverse Mercator) ¹⁸	a system for the world except polar region (see UPS)
			Transverse Mercator	smaller regions, with north-south extent
		oblique	Gauß-Krüger Gauß-Boaga	
	Rosenmund Oblique Mercator Hotine Oblique Mercator Laborde Oblique Mercator		smaller regions, oblique and east-west extent	
	cone	normal	Lambert Conformal Conic	smaller regions, oblique and east-west extent (1 or 2 standard parallels)
	plane	any aspect	stereographic	small regions up to hemisphere
polar		UPS (Universal Polar Stereographic)	polar regions, (other regions see UTM)	
<i>equal area</i>	cylinder	normal	cylindrical equal area by Lambert	equatorial with east-west extent
	pseudo cylinder	normal	Eckert IV Eckert VI Mollweide Sinusoidal	World
			cone	Albers equal area
	pseudo cone		Bonne	smaller regions, east-west extent
	plane	any aspect	Lambert Azimuthal Equal Area	smaller regions, about same north-south, east-west extent
		mainly equatorial	Hammer-Aitoff	World
<i>equidistant</i>	cylinder	normal	Platt (Plate Carrée)	World
		transverse	Cassini Soldner	locally used for large scale mapping
	cone	normal	equidistant conic	smaller regions and continents with (1 or two standard parallels) east-west extent
	plane	any aspect	azimuthal equidistant	smaller regions, about same north-south, east-west extent
<i>others</i>	poly-superficial	normal	Polyconic	locally used for large scale mapping

Table 1:
Overview about often used map projections together with their extential main use.

Map projections always are related to an underlying Earth model and its datum. This has to be considered (see Figure 5). If not considering the correct datum, it may affect enormous errors in the horizontal position (hundreds of meters up to more than 1 km). A lot of projections e.g. for world mapping are only used or implemented in current GIS tools on the spherical projections. Thereby, the proper transformation between the ellipsoid and the sphere has to be considered.

Projections and Change of Datum

¹⁸ has ambiguous implementations, varying in zone definition and underlying datum and ellipsoid.

Figure 5:
The change between two map projections is related to the underlying Earth model and its datum. Therefore the geodetic datum transformation has to be considered.

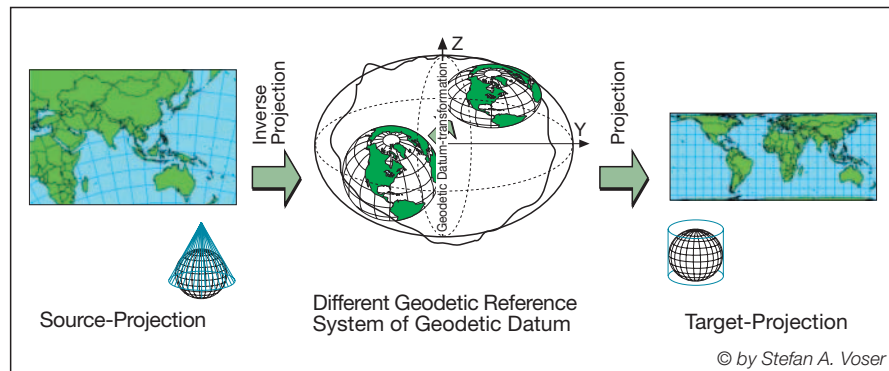

Conclusions

Map projections are used for a flat representation of the spheroidal figure of the Earth. When deciding to instantiate a projection for a purpose, various geometric analyses have to be made, and normally, they should be compared with alternative projections. The instantiation of a projection on one hand depends on the geometric properties and the portrayal of the graticul. On the other hand, also its technical implementation for applying them for digital geospatial data and their processing has to be considered as well. Map projections are an important subject of a comprehensive coordinate reference system management (CRSM) (See e.g. [Voser 1998, Voser 2002]).

References

- [1] [Annoni, Luzet 2000] Annoni, Alessandro; Luzet, Claude (Eds.): Spatial Reference Systems for Europe; A joint initiative of Megrin and the Space Application Institute; Workshop 29-30 November 1999, Marne - La Vallée; Proceedings and Recommendations; European Commission EUR 19575 EN, 2000.
- [2] [Annoni, et al. 2002] current proceedings.
- [3] [Bugayevskiy 1995] Bugayevskiy Lev M., Snyder John P.: Map Projections, A Reference Manual, Taylor&Francis, London, Bristol 1995.
- [4] [Goussinsky 1951] Goussinsky, B.: On the Classification of Map Projections. In: Empire Survey Review, 1951., Vol. II; p. 75-79.
- [5] [Hooijberg 1997] Hooijberg Maarten; Practical Geodesy - Using Computers. Springer Verlag, Berlin Heidelberg, 1997.
- [6] [Lee 1944] Lee, L.P; On the Nomenclature and Classification of Map Projections. In: Empire Survey Review, No. 51, Vol VII, Jan1944, p 190-200.
- [7] [MapRef] The MapRef Collection at <http://www.mapref.org>, since 1996.
- [8] [Richardus/Adler 1974] Richardus, Peter; Adler Ron K.: Map Projections for geodesists, cartographers and geographers; North-Holland Publishing Company, Amsterdam, Oxford, 1974.
- [9] [Snyder 1987] Snyder, John P.; Map Projections - A working manual; U.S. Geological Survey Professional Paper 1395; Washington 1987.
- [10] [Voser 1998] Voser S.A.: Schritte für ein automatisiertes Koordinatensystemmanagement in GIS und Kartographie. (Steps towards an automated coordinate system managment in GIS and Cartography.) Nachrichten aus dem Karten- und Vermessungswesen, Reihe I, Heft Nr. 118, S. 111-125., Bundesamt für Kartographie und Geodäsie, Frankfurt am Main, 1998.
- [11] [Voser 2000] Voser, Stefan A.: The Internet Collection of Map Projections and Reference Systems for Europe; in [Annoni, Luzet 2000], p. 66-73.
- [12] [Voser 2002] Voser, Stefan A; The Future of Coordinate Reference Systems, in [Annoni, et al. 2002].

Coordinate Reference Systems used in Europe - Including Map Projections - *J. Ihde, J. Luthardt, C. Boucher, P. Dunkley, E. Gubler, B. Farrell, J.A. Torres*

On behalf of the European Commission (EC) at the end of 1999 a Spatial Reference Workshop was organized by MEGRIN to recommend common European reference systems for geoinformation systems and data of the EC and for the member states. The IAG Subcommission for Europe (EUREF) works for over 10 years actively and continuously together with the national mapping agencies for the realization of the ETRS89 and since 1995 on the United European Levelling Network. Therefore, EUREF was well prepared and able to answer the requests. EUREF and the Work Group VIII of the Comité Européen des Responsables de la Cartographie Officielle (CERCO) were asked to prepare relevant information describing the systems and the transformation from the national reference frames to the European one.

The Spatial Reference Workshop recommended that the European Commission:

- adopts ETRS89 as the geodetic datum for the geo-referenced coordinates of its own data
- the coordinates for expressing positions related to ETRS89 datum will normally be ellipsoidal (geodetic latitude, geodetic longitude, and if appropriate ellipsoidal height)
- defined its various needs for map projections and to obtain further expert advice to determine the appropriate projections
- adopts the results of the EUVN/UELN initiatives when available, as definitions of vertical datum and gravity-related heights
- Both the ETRS89 and the current national coordinate reference systems for spatial reference and both a European vertical datum and the current national height systems for height reference will continue for many years in parallel. From this point of view the workshop recommends to the NMAs that transformation parameters and algorithms to and from ETRS89 providing coordinates of an accuracy level of 1-2 m should be placed in the public domain.

This paper gives an overview about the standardisation approach and the status of the action following the spatial reference workshop.

The ISO/TC 211 Geographic Information started with its works in the field of standardization of digital geographic information in 1994 (1st plenary Nov. 1994, Oslo) and has now 5 WGs and more than 30 work items (WI).

This work aims to establish a structured set of standards for information concerning objects or phenomena that are directly or indirectly associated with a location relative to the Earth. These standards may specify, for geographic information, methods, tools and services for data management (including definition and description), acquiring, processing, analyzing, accessing, presenting and transferring such data in digital/electronic form between different users, systems and locations.

This work shall link to appropriate standards for information technology and data where possible, and provide a framework for the development of sector-specific applications using geographic data. The ISO/TC 211, WI 11 - Spatial referencing by coordinates (ISO 19111) standard - was not made for geodetic experts, it was made for producers and users of GIS. Therefore the structure shall be clear and easy - but correct on a common level of abstraction.

ISO 19111 describes the conceptual schema and defines the description for a minimum data to two cases for which 1-, 2- and 3-dimensional coordinate reference system information shall be given:

Case A: A coordinate reference system to which a set of coordinates is related.

Case B: A coordinate operation (coordinate transformation, coordinate conversion, concatenated coordinate operation) to change coordinate values from one coordinate reference system to another.

Introduction

Standardisation Activities

Coordinate Reference Systems

The coordinate reference system (CRS) is an aggregate class with the component classes datum and coordinate system, geodetic datum, vertical datum and engineering datum are subclasses to the datum:

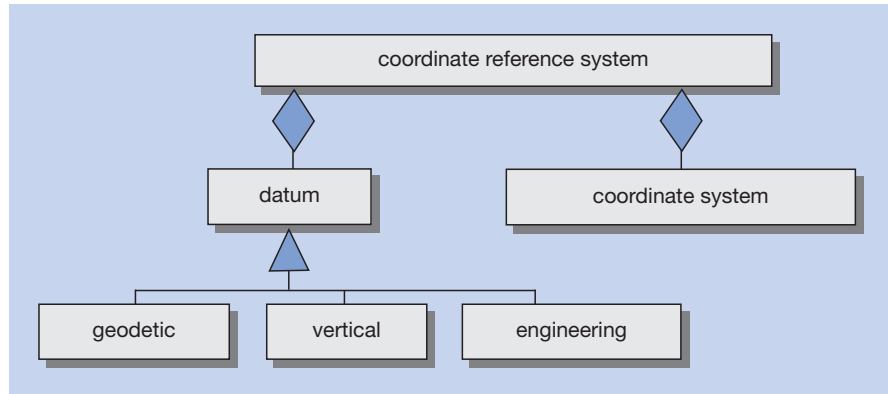

The following schema contains the definitions of CRS, datum and coordinate system:

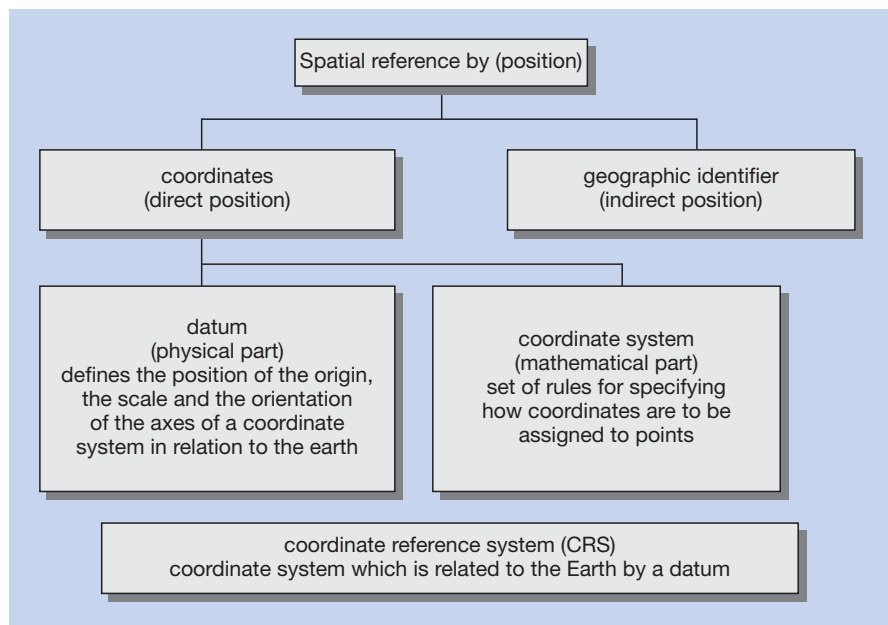

Annex 1 contains the schema with the elements describing a CRS (example: ETRS89/Cartesian coordinates).

The horizontal and vertical components of the description of a position in the space may sometimes come from different CRS. This shall be handled through a compound coordinate reference system (CCRS). The CCRS describes the position through two independent coordinate reference systems.

An unambiguous European spatial reference system could be described as a CCRS:

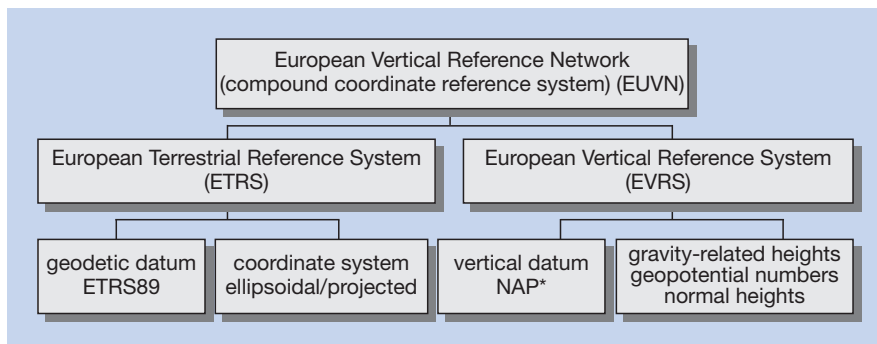

A coordinate operation is a change of coordinates, from one coordinate reference system to another. Coordinate transformations and coordinate conversions are subtypes of coordinate operations:

Coordinate Operations

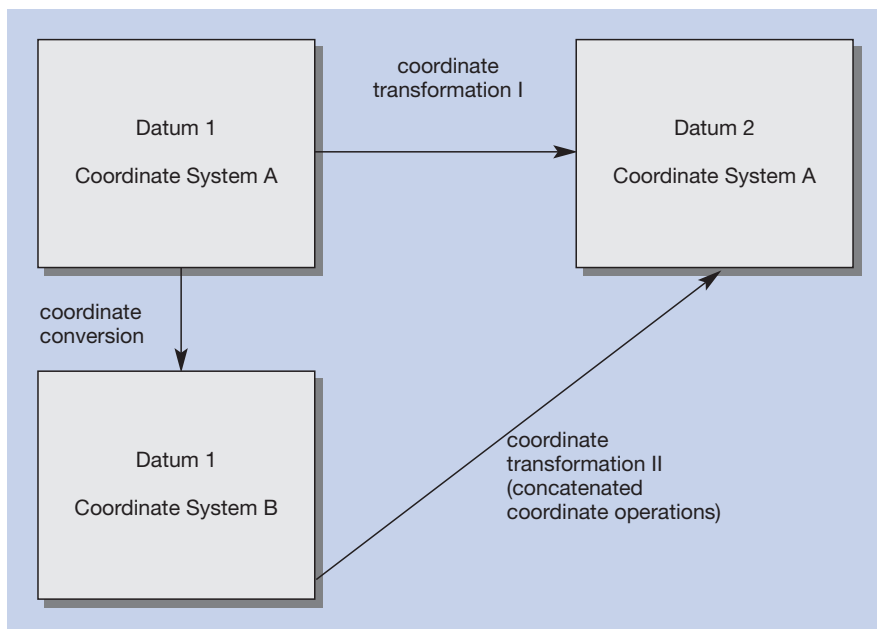

Annex 2 contains the schema with the elements describing a coordinate operation in the case of coordinate transformation (example: transformation from German geodetic datum DHDN to ETRS89).

A coordinate conversion is a change of coordinates, from one coordinate system to another based on the same datum, for example between the geodetic and the cartesian coordinate systems or between geodetic coordinates and projected coordinates, or change of units such as from radians to degrees or feet to meters. A coordinate conversion uses parameters which have constant values:

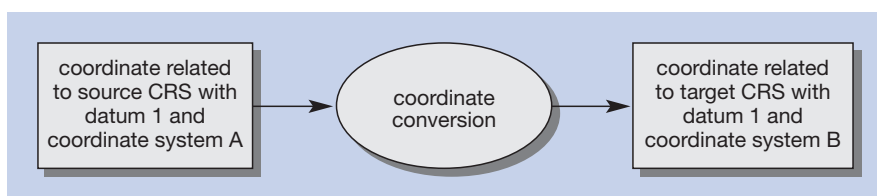

* Normaal Amsterdams Peil (NAP)

A coordinate transformation is a change of coordinates from one coordinate reference system to another coordinate reference system based on a different datum:

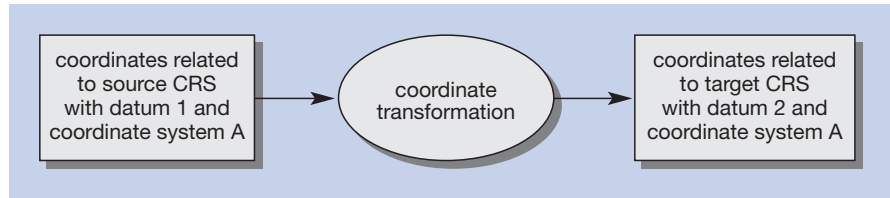

A coordinate transformation uses parameters which may have to be derived empirically by a set of points common to both coordinate reference systems.

The formula of the 7-Parameter-Helmert-Transformation shall be used for all coordinate transformations:

$$\begin{aligned} \begin{bmatrix} X \\ Y \\ Z \end{bmatrix}_{(T)} &= \begin{bmatrix} X \\ Y \\ Z \end{bmatrix}_{(S)} + \begin{bmatrix} T_1 \\ T_2 \\ T_3 \end{bmatrix} + \begin{bmatrix} 0 & -R_3 & R_2 \\ R_3 & 0 & -R_1 \\ -R_2 & R_1 & 0 \end{bmatrix} \begin{bmatrix} X \\ Y \\ Z \end{bmatrix}_{(S)} + D \begin{bmatrix} X \\ Y \\ Z \end{bmatrix}_{(S)} \\ &= \begin{bmatrix} T_1 \\ T_2 \\ T_3 \end{bmatrix} + \begin{bmatrix} 1+D & -R_3 & R_2 \\ R_3 & 1+D & -R_1 \\ -R_2 & R_1 & 1+D \end{bmatrix} \begin{bmatrix} X \\ Y \\ Z \end{bmatrix}_{(S)} \end{aligned}$$

- (T) Target Datum
- (S) Source Datum
- T_1, T_2, T_3 geocentric X/Y/Z translations [m]
- R_1, R_2, R_3 rotations around X/Y/Z axis [radian]
- D correction of scale [ppm]

(Remark: the rotations R_1, R_2, R_3 must be small)

The change of coordinates from one coordinate reference system to another coordinate reference system may follow from a series of operations consisting of one or more transformations and/or one or more conversions. A concatenated operation records a change of coordinates through several transformations and/or conversions. There is no upper limit to the number of steps a concatenated operation may have. Each step is an operation described in the normal way. The figure shows a two-step concatenated operation:

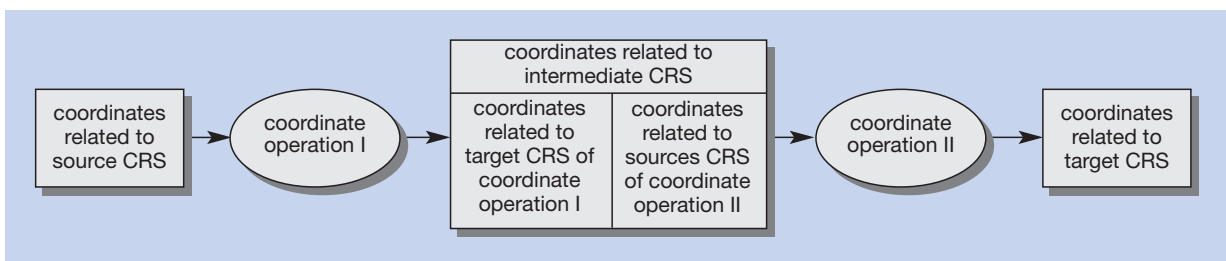

The relationship between coordinates in a European coordinate reference system, a national coordinate reference system, and a European projection represents as following:

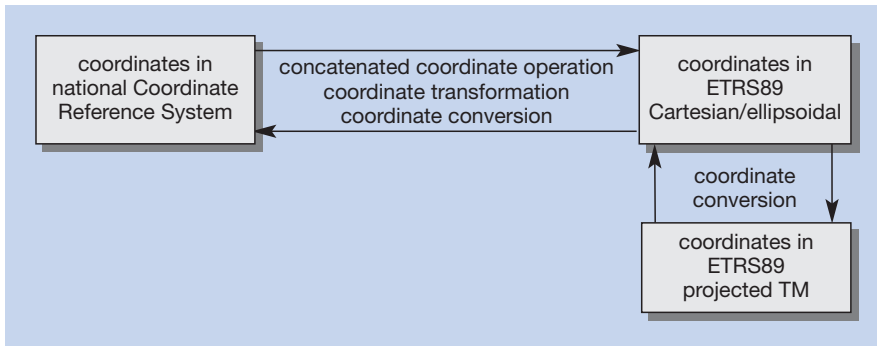

Under the head of ISO/TC 211 it is not planned to standardise a special CRS for worldwide GIS users, e.g. ITRS. A new work item with geodetic relevance “Geodetic codes and parameters” started in the year 2000 but cannot take over the function of a standard CRS. It is the task of political, technical and scientific organisations or commissions to define reference systems as defacto standards for GIS applications, as to be done by the spatial reference workshop, EUREF and CERCO with their activities.

Two EUREF activities were initiated from the urgent requests of the Spatial Reference Workshop. EUREF was asked to define a European vertical datum based on the EUVN and UELN initiatives in the year 2000 (see Ihde and Augath). Furthermore the TWG EUREF was asked together with the Work Group VIII of CERCO (now EuroGeographics) to manage the collection of relevant transformation data, and its publication in the year 2001.

A common letter (Annex 3) of CERCO and EUREF was send out to the NMAs of CERCO/EUREF countries in May 2000 for gathering the information of national European coordinate reference systems defined by a national datum and a coordinate system and of the relations (operations) between national and a conventional European coordinate reference system (between the datums - as coordinate transformation - and between the coordinate systems - as coordinate conversion).

The letter includes the available information about national coordinate reference systems and the information about the coordinate transformation to ETRS89. The information are stored in a relational data base regarding the conventions and tables of ISO 19111 standard. With the response of the countries the information system will be updated and more information will be added. In a public domain the information should be available through Internet.

In cooperation von BKG, EUREF and EuroGeographics the information system was established and is hosted at BKG, Branch Leipzig. The structure is shown in the following scheme:

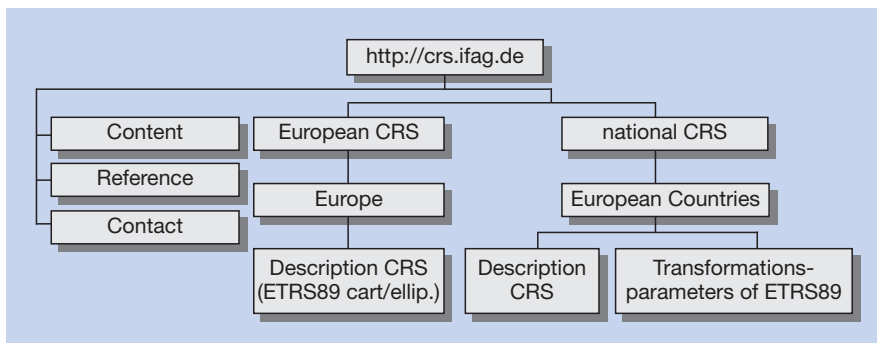

Activities of EUREF and CERCO

Information system of European Coordinate Reference Systems

The users have the possibility to get the available information for pan European CRS and national CRS. For whole Europe at present ETRS89 in Cartesian and ellipsoidal coordinates available. For European countries after selecting a country the information

- Description of CRS and
- Description of Transformation to ETRS89

are regarding ISO-Standard 19111 (see Table 2: examples for Austria) shown at the web pages.

Map Projections and CRS used in Europe

The response of the NMA and the content of the information system open the possibility to give an overview about CRS and map projections at the present level of knowledge (see Table 3, Table 4 and Figure 6).

Recommendations for pan-European Map Projections

It is proposed that the Map Projection Workshop recommends that the European Commission:

- adopt ellipsoidal coordinates (geodetic latitude, geodetic longitude, and if appropriate ellipsoidal height) for expressing positions of vector data
- adopt the UTM projection system for topographic maps with scales larger than 1:500,000
- adopt the Lambert conformal projection (LCC) with two parallels for cartographic maps with scales equal 1:500,000 or less
- include the above coordinate systems in the future specifications of the products to be delivered to the EC, within projects, contracts, etc
- further promote the wider use of the above coordinate systems within all member states, by appropriate means (recommendations, official statements, ...).

Table 2: Examples for describing a CRS and a transformation.

Description of Coordinate Reference System (CRS) Example Austria - AT_MGI /AT_TM	
Country	Austria
Country identifier	AT
CRS identifier	AT_MGI / AT_TM
CRS alias	
CRS valid area	Austria
Datum identifier	MGI
Datum alias	Militärgeographisches Institut
Datum type	Geodetic
Datum anchor point	Austria, Hermannskogel, Habsburgwarte, Lat=48°16'15.2900" N, Lon=16°17'41.0600" E (wrt.Greenwich)
Datum valid area	Austria
Datum scope	
Datum remarks	
Prime meridian identifier	Ferro
Prime meridian greenwich longitude	17°40' W
Prime meridian remarks	
Ellipsoid identifier	Bessel 1841
Ellipsoid alias	
Ellipsoid semi major axis	6 377 397.155 m
Ellipsoid shape	true
Ellipsoid inverse flattening	299.15281285
Ellipsoid remarks	
Coordinate system identifier	AT_TM
Coordinate system type	Projected
Coordinate system dimension	2
Coordinate system remarks	
Coordinate systemaxis name	X / northing
Coordinate system axis direction	North
Coordinate system axis unit	meter
Coordinate system axis name	Y / easting
Coordinate system axis direction	East
Coordinate system axis unit ID	meter
Operation identifier	AT_TM
Operation valid area	Austria
Operation method name	Transverse Mercator Projection
Operation method name alias	Gauss Krüger Projection
Operation method formula	Transverse Mercator Mapping Equations, in Hooijberg, Practical Geodesy, 1997, pages 81-84
Operation method parameters number	6
Operation method remarks	Transverse Mercator Projection, 3 gradwidth, individual central meridians wrt. Ferro
Operation parameter name	latitude of origin
Operation parameter value	0°
Operation parameter remarks	0°, the Equator
Operation parameter name	longitude of origin
Operation parameter value	central meridians 28° E, 31° E, 34° E wrt. Ferro
Operation parameter remarks	central meridian (CM) of eachzone
Operation parameter name	false northing
Operation parameter value	0 m
Operation parameter remarks	
Operation parameter name	false easting
Operation parameter value	0 m
Operation parameter remarks	zone number are explicit
Operation parameter name	scale factor at central meridian
Operation parameter value	1.0000
Operation parameter remarks	
Operation parameter name	width of zone
Operation parameter value	3°
Operation parameter remarks	

Description of Transformation to ETRS89 Example Austria — AT_MGI to ETRS89	
Operation identifier	AT_MGI to ETRS89
Country	Austria
Country identifier	AT
Operation valid area	Austria
Operation scope	for applications with an accuracy of about 1.5 m
Source coordinate reference system ID	AT_MGI (X, Y, Z)
Target coordinate reference system ID	ETRS89 (X, Y, Z)
Operation version	1996, 84 identical points
Operation method name	7 Parameter Helmert Transformation
Operation method name alias	3D similarity transformation
Operation method formula	7 Parameter Helmert Transformation, $\begin{bmatrix} X \\ Y \\ Z \end{bmatrix}_{(T)} = \begin{bmatrix} X \\ Y \\ Z \end{bmatrix}_{(S)} + \begin{bmatrix} T_1 \\ T_2 \\ T_3 \end{bmatrix} + \begin{bmatrix} 0 & -R_3 & R_2 \\ R_3 & 0 & -R_1 \\ -R_2 & R_1 & 0 \end{bmatrix} \begin{bmatrix} X \\ Y \\ Z \end{bmatrix}_{(S)} + D \begin{bmatrix} X \\ Y \\ Z \end{bmatrix}_{(S)}$ <p>(T) Target Datum (S) Source Datum T₁, T₂, T₃ geocentric X/Y/Z translations [m] R₁, R₂, R₃ rotations around X/Y/Z axis [radian] D correction of scale [ppm]</p> <ul style="list-style-type: none"> - or see- ISO/CD 19111, Annex D, D3 Datum Transformationen - or- Boucher, C., Altamimi, Z.(1992): The EUREF Terrestrial Reference System and its First Realizations. Veröffentlichungen der Bayerischen Kommission für die Internationale Erdmessung, Heft 52, München1992, Pages 205-213 - or- Ftp://lareg.ensg.ign.fr/pub/euref/info/guidelines/REF.FRAME.SPECIFV4
Operation method parameters numb.	7
Operation method remarks	The three-dimensional coordinates of (X,Y,Z) of AT_MGI were derived under using ellipsoidal heights, which are computed from levelling heights related to Molo Sartorio (Trieste) and a Geoid related to AT_MGI Datum Hermannskogel and Josefstadt in Bohemia REMARK:for transformation the (ellip) coord. must refer all to Prime Meridian Greenwich
Operation parameter name	geocentric X translation
Operation parameter value	+577.3 m
Operation parameter remarks	
Operation parameter name	geocentric Y translation
Operation parameter value	+90.1 m
Operation parameter remarks	
Operation parameter name	geocentric Z translation
Operation parameter value	+463.9 m
Operation parameter remarks	
Operation parameter name	rotation X-axis
Operation parameter value	+5.137"
Operation parameter remarks	to be in agreement with formulas the rotation parameter has to be converted to Radians
Operation parameter name	Rotation Y-axis
Operation parameter value	+1.474"
Operation parameter remarks	to bein agreement with formulas the rotation parameter has to be converted to Radians
Operation parameter name	Rotation Z-axis
Operation parameter value	+5.297"
Operation parameter remarks	to be in agreement with formulas the rotation parameter has to be converted to Radians
Operation parameter name	correction of scale
Operation parameter value	
Operation parameter remarks	

Table 3: National Coordinate Reference Systems in Europe.

Country	Coordinate Reference System Identifier <country>_<datum>/>coord. system or projection>	geodetic Datum	Projection
Albania	AL_ALB87_TM_6	ALB87	Transverse Mercator
Austria	AT_MGI/AT_TM	MGI	Transverse Mercator
Belgium	BE_BD72/LAMB72	BD72	Lambert Conformal Conic
Bulgaria	BG_1942/GK_3 BG_1942/TM_6	1942 1942	Transverse Mercator (Gauss-Krüger-System) Transverse Mercator
Croatia	HR_HDKS/HR_TM	HDKS	Transverse Mercator (~Gauss-Krüger-System)
Cyprus	CY_ED50/UTM	ED50	Transverse Mercator (UTM)
Czech Rep.	CZ_S-JTSK/KROVAK	S-JTSK	Oblique Conformal Conic
Denmark	DK_ED50/UTM	ED50	Transverse Mercator (UTM)
Estonia	EE_L-EST97/EST_LAMB	L-EST97	Lambert Conformal Conic
Finland	FI_KKJ/FI_TM	KKJ	Transverse Mercator
France	FR_ED50/EUROLAMB FR_RGF93/LAMB93 FR_NTF/FR_LAMB	ED50 RGF93 NTF	Lambert Conformal Conic Lambert Conformal Conic Lambert Conformal Conic
Germany	DE_ETRS89/UTM DE_PD83/GK_3 DE_42/83/ GK_3 DE_DHDN/GK_3 DE_RD83/GK_3	ETRS89 PD83 42/83 DHDN RD83	Transverse Mercator (UTM) Transverse Mercator (Gauss-Krüger-System) Transverse Mercator (Gauss-Krüger-System) Transverse Mercator (Gauss-Krüger-System) Transverse Mercator (Gauss-Krüger-System)
Gibraltar	GI_ED50/UTM	ED50	Transverse Mercator (UTM)
Great Britain	GB_OSGB36/NATIONALGRID	OSGB36	Transverse Mercator
Greece	GR_GGRS87/GR_TM	GGRS87	Transverse Mercator
Hungary	HU_HD72/EOV	HD72	Oblique Conformal Cylindric
Iceland	IS_HJ1955/UTM	HJ1955	Transverse Mercator (UTM)
Ireland	IE_IRELAND65/IRELAND75_IRISHGRID	IRELAND65	Transverse Mercator
Italy	IT_ED50/UTM IT_ROMA40/EAST_WEST	ED50 ROMA40	Transverse Mercator (UTM) Transverse Mercator
Lithuania	LT_LKS94/LT_TM	LKS94	Transverse Mercator
Luxembourg	LU_LUREF/LU_TM	LUREF	Transverse Mercator
Malta	MT_ED50/UTM	ED50	Transverse Mercator (UTM)
Netherlands	NL_RD/DUTCH_ST	RD	Oblique Stereographic
Northern Ireland	NI_IRELAND65/IRELAND75_IRISHGRID	IRELAND65	Transverse Mercator
Norway	NO_ETRS89/UTM NO_NGO1948/NO_TM	ETRS89 NGO1948	Transverse Mercator (UTM) Transverse Mercator
Poland	PL_42/58/1965 PL_EUREF89/1992 PL_EUREF89/2000	42/58 EUREF89 EUREF89	Oblique Stereogr. (Zone 1...4)/Transv. Mercator (Zone 5) Transverse Mercator Transverse Mercator
Portugal	PT_DLX(HAY)/TM_DLX PT_DLX(BES)/BONNE PT_AZO_CENT/UTM PT_AZO_OCCI/UTM PT_AZO_ORIE/UTM PT_MAD/UTM PT_D73/TM_D73	DLX(HAY) DLX(BES) AZO_CENT AZO_OCCI AZO_ORIE MAD D73	Transverse Mercator Bonne Transverse Mercator (UTM) Transverse Mercator (UTM) Transverse Mercator (UTM) Transverse Mercator (UTM) Transverse Mercator
Romania	RO_S42(89)/TM_6 RO_S42(89)/ST1970	S42(89) S42(89)	Transverse Mercator Oblique Stereographic
Russia	RU_...		Transverse Mercator
Slovak Rep.	SK_S-JTSK/KROVAK	S-JTSK	Oblique Conformal Conic
Slovenia	SI_D48/SI_TM	D48	Transverse Mercator (~Gauss-Krüger-System)
Spain	ES_ED50/UTM	ED50	Transverse Mercator (UTM)
Sweden	SE_RT90/SE_TM	RT90	Transverse Mercator
Switzerland	CH_CH1903+/CH_PROJECTION+ CH_CH1903/CH_PROJECTION	1903+ 1903	Oblique Conformal Cylindric Oblique Conformal Cylindric
Turkey	TR_ED50/UTM TR_ED50/TR_TM	ED50 ED50	Transverse Mercator (UTM) Transverse Mercator
Ukraine	UA_...		Transverse Mercator

Map Projection	Country	Map Projection	Country
Transverse Mercator (transversal, cylindrical, conformal)	Albania	Gauss-Krüger-System special German specification of Transverse Mercator Projection	Bulgaria
	Austria		Croatia
	Bulgaria		Germany
	Finland		Slovenia
	Great Britain		
	Greece	Lambert Conformal Conic	Belgium
	Ireland		Estonia
	Italy		France
	Lithuania	Oblique Conformal Conic	Czech Rep.
	Luxembourg		Slovak Rep.
	Northern Ireland		
	Norway		
	Poland	Oblique Conformal Cylindric	Hungary
	Portugal		Switzerland
	Romania	Oblique Stereographic	Netherlands
	Russia		Poland
	Sweden		Romania
	Turkey	Bonne	Portugal
	Ukraine		
Universal Transverse Mercator special United States specification of Transverse Mercator Projection - parameter world wide valid - used by NATO - de facto Standard	Cyprus		
	Denmark		
	Germany		
	Gibraltar		
	Iceland		
	Italy		
	Malta		
	Norway		
	Portugal		
	Spain		
	Turkey		

Table 4:
Map Projections used
in Europe.

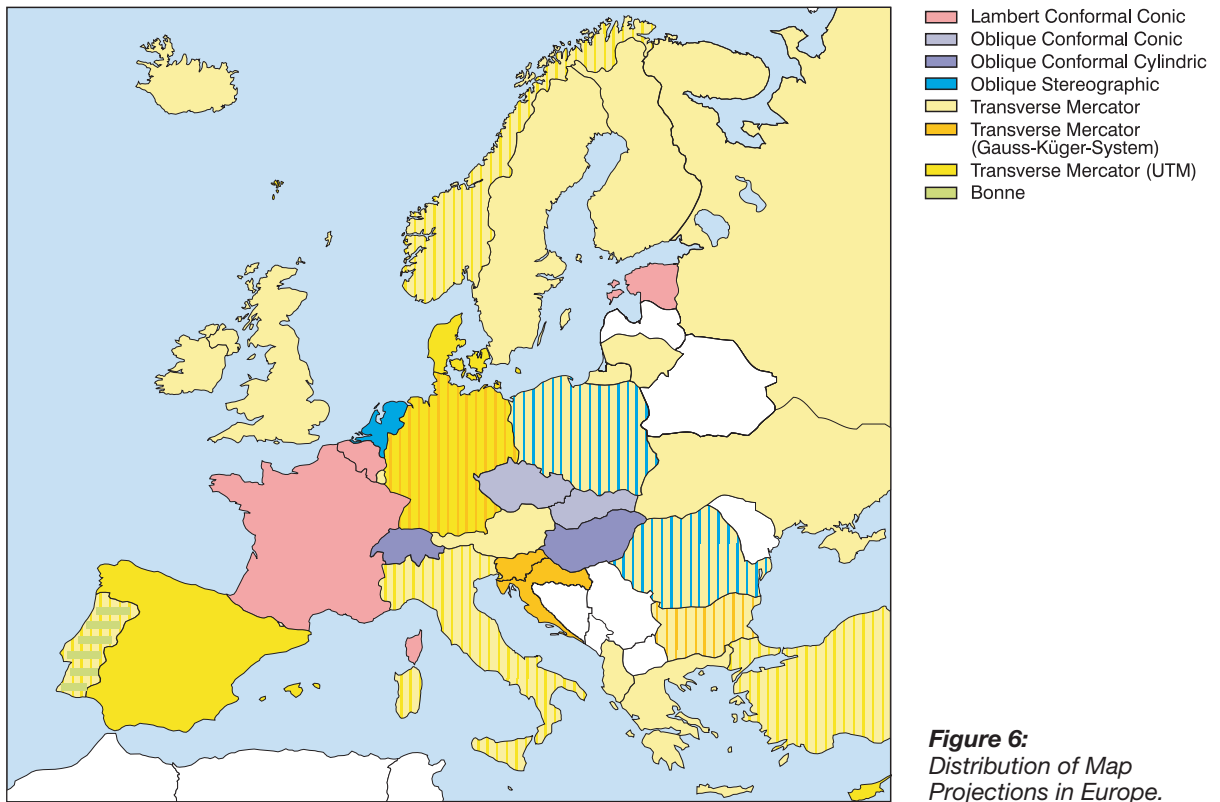
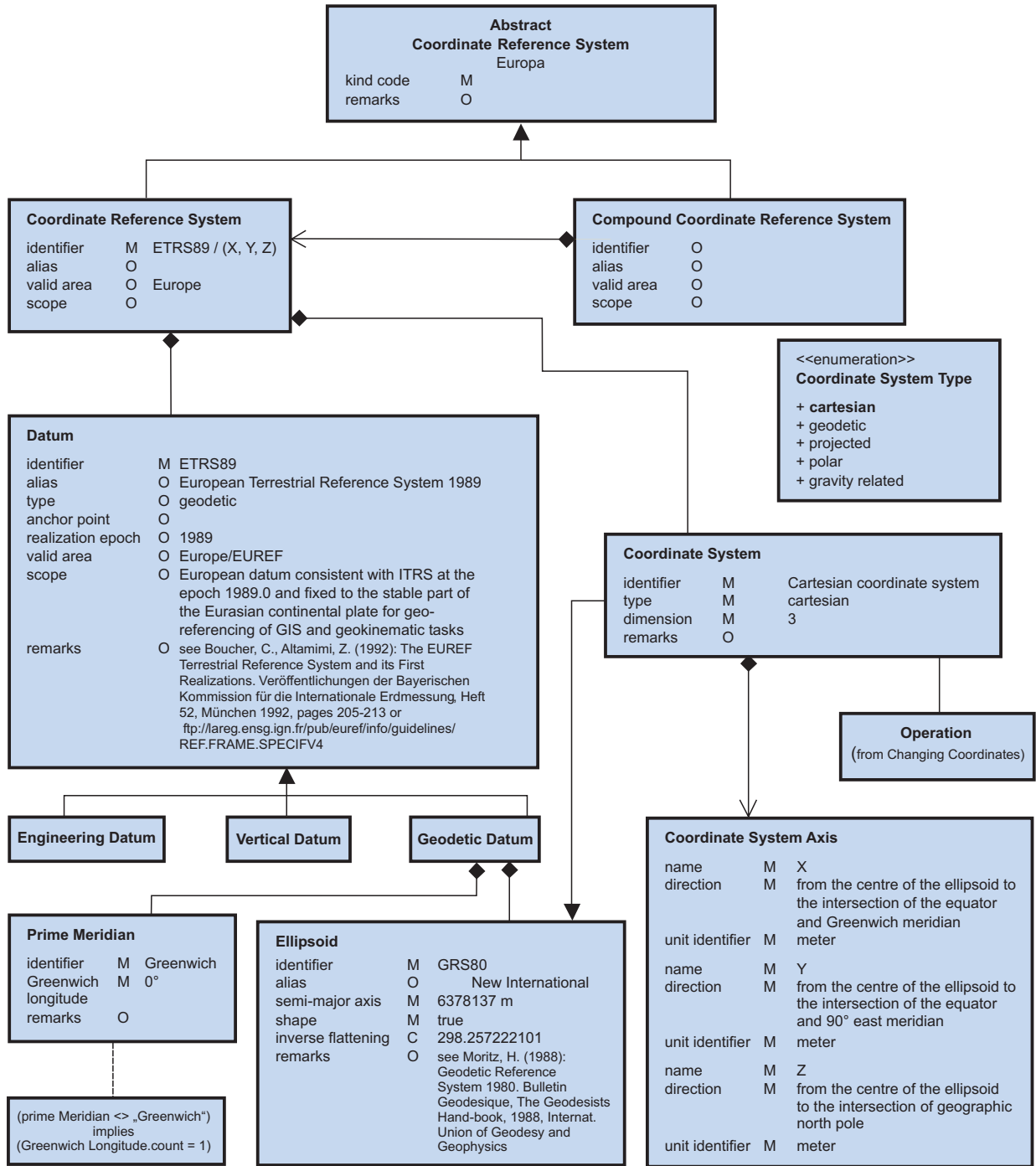

Figure 6:
Distribution of Map
Projections in Europe.

References

- [1] Annoni A., Luzet C. (Editors; 2000): Spatial Reference Systems for Europe, Proceedings & Recommendations of Workshop, Marne – La Vallée, 29-30 Nov. '99, In: www.ec-gis.org
- [2] Ihde J., Augath W.: The Vertical Reference System for Europe. Presented at the EUREF Symposium, Tromsø, June, 22-24, 2000. In: Veröffentlichungen der Bayerischen Kommission für die Internationale Erdmessung. München, 2001, Heft Nr. 61, S. 99 – 101.
- [3] European Vertical Reference System (EVRS), International Association of Geodesy, Section I – Positioning, Commission X – Global and Regional Networks, Subcommittee for Europe (EUREF). Presented at the EUREF Symposium, Tromsø, June, 22-24, 2000. In: Veröffentlichungen der Bayerischen Kommission für die Internationale Erdmessung. München, 2001, Heft Nr. 61, S. 101 – 113.

Annex 1 - Schema for describing a coordinate reference system – example ETRS89/Cartesian coordinates



Remark: The elements mandatory (M), optional (O) or conditional (C)

Annex 2 - Schema of describing a coordinate operation – example DE_DHDN to ETRS89

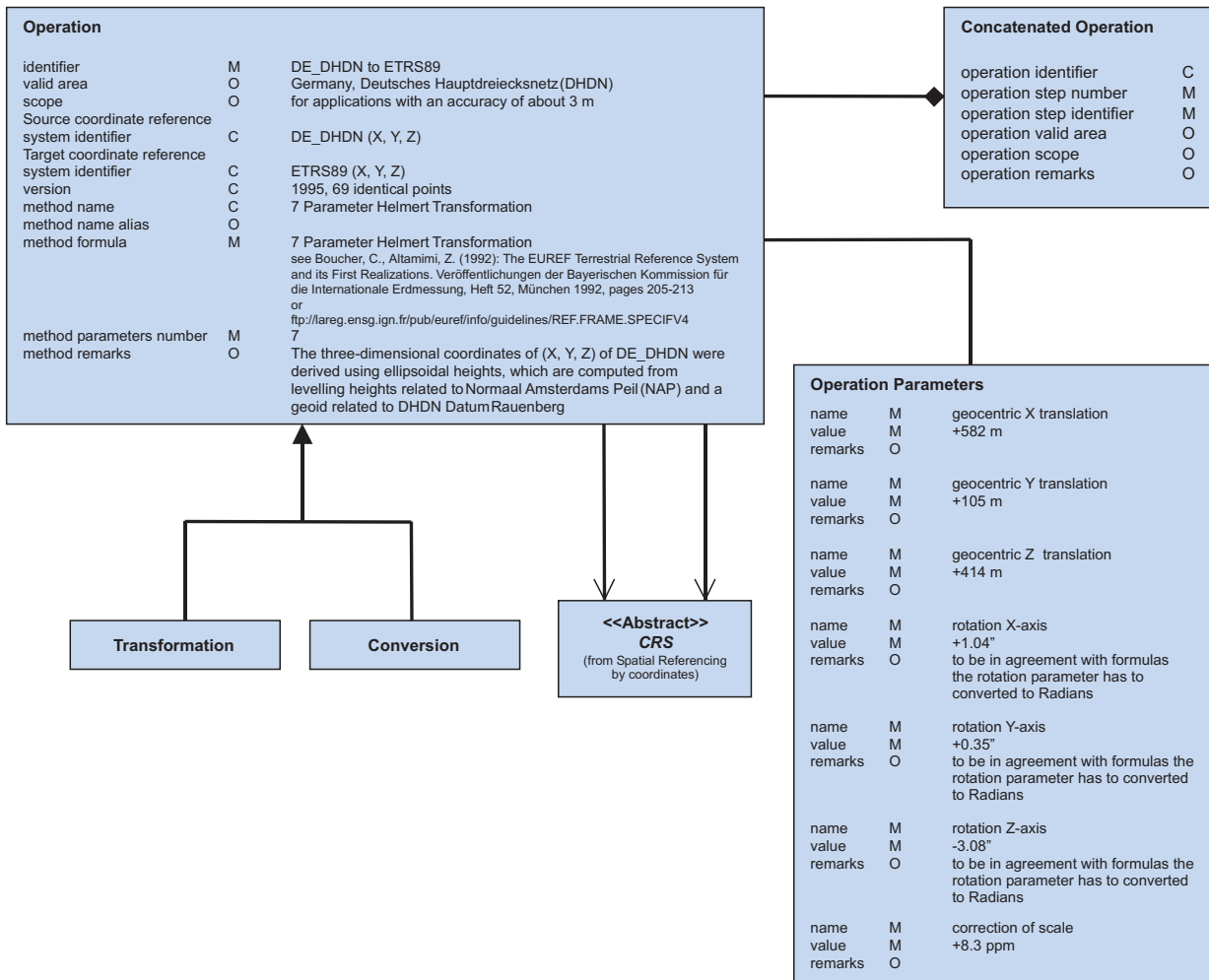

Remark: The elements mandatory (M), optional (O) or conditional (C)

Annex 3 - Letter of CERCO and EUREF to the European National Mapping Agencies



CERCO
Work Group VIII
Geodesy

To the National Mapping Agencies (NMA)

2000-06-05

Ladies and Gentlemen, dear colleagues,

I am writing to you in my function as President of CERCO Working Group VIII (Geodesy) and as a member of the Technical Working Group (TWG) of EUREF and I am asking for your support. As you certainly know, there is an increasing need for geographic information (GI) on an international scale for a large variety of purposes. Since all the national databases refer to national geodetic reference systems, GI from different countries cannot be combined easily.

The European Commission (EC) has asked MEGRIN to offer some support for this topic. At a Spatial Reference Workshop held near Paris in November 1999, a group of experts advised the EC to adopt the European Terrestrial Reference System ETRS89, established by the IAG Subcommission for Europe (EUREF), as the official reference system for Europe (see Appendix 6 "Short Proceedings, Conclusions & Recommendations"). In the future, all GI covering more than one country should refer to ETRS89 to make it compatible with all the other data sets. This means that there is an urgent need to perform transformations between all the national reference systems used in Europe and ETRS89. The participants of the workshop, therefore, recommended that the required information is to be made freely available with a minimum accuracy of 1 to 2 metres and that an address is published, where more accurate transformations can be performed, along with the official sources/owners of the information.

In addition to this request, MEGRIN also needs this capability for its LaClef project. Therefore, MEGRIN asked CERCO WG VIII and the EUREF Subcommission, which work closely together, to validate and make these transformations available as soon as possible. On the other hand, EUROCONTROL had collected the same information several years ago and would like to get these data checked and validated by the EUREF Subcommission as well.

On its meeting of March 20 to 21 in Brussels, the TWG decided to combine these tasks. Appendices 1 and 2 show the currently available data from different recognized sources of your country according to the ISO standard 19111. We ask you to check these data thoroughly,

correct false information, update phased-out data and supplement missing data and information. Appendix 3 shows examples.

To make sure that we have completely understood the information provided, we intend to perform some test computations at the Bundesamt für Kartographie und Geodäsie (BKG) and will choose a set of stations occupied in one or the other EUREF campaign for this purpose. In order to accomplish this task, we are asking you to give us the coordinates of the stations listed in Appendix 4 in your national system(s).

We intend to set up a web page containing all the available transformations with an accuracy of at least 1 to 2 metres, thus allowing easy transformations between ETRS89 and any national system, and with Appendix 5 we are officially asking you the permission to do so.

Please send the updated tables in Appendices 1 and 2 and the official permission to make the transformations publicly available (Appendix 4) not later than August 31, 2000 to Dr. J. Ihde

Bundesamt fuer Kartographie und Geodaesie
Aussenstelle Leipzig
Karl-Rothe-Strasse 10-14
D-04105 Leipzig, Germany
Phone: +49 341 5634 424
Fax: +49 341 5634 415
Email: ihde@leipzig.ifag.de

Please feel free to contact either Dr. Ihde or myself if you have any questions or remarks.

Yours sincerely,

Dr. Erich Gubler
CERCO WG
VIII

Appendices:

1. One (or several) Report(s): Coordinate Reference System (CRS, information currently available)
2. One (or several) Report(s): Transformation (information currently available)
3. Examples for 1. and 2.
4. List of EUREF stations intended for test transformations
5. Official permission to make transformations publicly available
6. Short Proceedings, Conclusions & Recommendations of the MEGRIN workshop

Problems and issues from the perspective of the National Mapping Agencies - *Lars E. Engberg*

Background

In Sweden, the task of Lantmäteriet (National Land Survey) is to contribute to an efficient and sustainable use of Sweden's real estate, land and water. Our specialisation in geographic information, land information, cadastral services and geographic information techniques puts us in a unique situation. In these four fields we have the national responsibility and a leading role. Lantmäteriet (National Land Survey) has the responsibility for the national geodetic control networks as well as the national topographical and cadastral maps. National Maps (1:1,000,000 - 1:10,000) and National Cadastral Maps (1:10,000) are produced. Geographic Swedish Data (GSD) is the generic name for a set of databases containing basic, spatially related geographic data. The production of GSD is partly coordinated with the production of the national map series and partly carried out in conjunction with a project aimed at rapidly creating a national coverage for some special themes. The geodetic infrastructure is also used for mapping in large scales (1:500) and construction works (1:1).

The History of the Projections of Today

Sweden has presently a Gauss-Krüger projection. It was introduced for triangulation works in the southern part of the country in the first decade of the twentieth century. The table below shows the chosen values for the projection-parameters.

Parameters chosen for Bessel's ellipsoid and Gaussian projection

Half major axis (a)	6 377 397.154 171 m
Half minor axis (b)	6 356 078.961 995 m
Central meridian (λ_0)	15° 48' 29.8" E*
Scale reduction factor (k_0)	1

*2.5 gon W of the old Observatory in Stockholm

In the 1920s this projection together with a system of zones with 2.5 gon (2° 15') between central meridians was also introduced for cadastral works in rural areas. The cities mostly had their own local systems. Since 1946 the new topographic map at 1:50,000 scale and the economical map at 1:10,000 scale were produced in a grid system based on this Gaussian projection. The whole country of Sweden can be continuously mapped on plane with a maximum linear distortion of 1700 ppm (i.e. millimetre per kilometre). The ellipsoid parameters as well as the projection parameters have been unchanged until 1993 when we did a slight change in the definition of the ellipsoid.

Parameters chosen for Bessel's ellipsoid and Gaussian projection

Half major axis (a)	6 377 397.155 m
Flattening (f)	1:299.1528128
Central meridian (λ_0)	15° 48' 29.8" E
Scale reduction factor (k_0)	1

The Use of Plane Co-ordinate-systems

There is a long tradition in Sweden that all surveying activities are using plane coordinates. Everything, from utility surveys to triangulation networks has been performed in the projection plane. All observations were of course corrected for distortions, linear as well as in directions.

Introducing a New Reference System

In order to meet the needs for spatial information of the society of tomorrow we have decided to introduce a new globally adopted geodetic reference system. We have, based on ETRS 89, established a reference frame, SWEREF 99, which was approved by EUREF last summer. Before introducing this new system to all users it is a must that we have a map projection connected to it. Otherwise no user will be able to use practically this new reference system. It is for some reasons important that this new system will be accepted as a common system because the first control networks for municipalities were established in the beginning of this century. Most of them were in a very weak way connected to the national network prevailing at that time in Sweden. Since then control networks have been established in almost every urban area.

Nowadays, we have 289 local authorities and almost every municipality has its own control network. Today, in some areas, there is more than one network because a forming of two or more into one municipality has taken place. Lantmäteriet (National Land Survey) is the national geodetic authority but has no power against municipalities and other authorities. Lantmäteriet cannot dictate anything in this field, just propose or give advice. If we shall succeed to convince all users that a common system is a good option, we have to look in the future and try to describe the efficiency of the new technique.

As indicated above, a map projection must be connected to the new reference system SWEREF 99. During 2001 there will be several seminars and workshops handling the question of map projection. Most of the users are not familiar with these questions; therefore the seminars will be performed for education purposes.

The “new” map projection should aim to:

- be used for the whole of Sweden and in some zones for large scale work,
- facilitate data exchanges with the neighbouring countries and with the European Union.

This new projection needs, as the old one, to be conformal and probably we will choose a Gaussian type of projection. Most of the users in Sweden have some knowledge and software required to handle a Gaussian projection. It is also important to remember that the purpose is not just to find a projection for topographical and economical maps, it is a part of the geodetic infrastructure in Sweden.

UTM is a well-known and widely used projection for topographical (military) maps. However, it has some characteristics that are drawbacks when using it for large scale (1:1) works:

- scale reduction factor $\neq 1$
- too wide zones \Rightarrow large linear distortion in large scale works.

The scale reduction factor ($=0.9996$) results in the fact that areas approximately 180 km from the central meridian get the scale factor $=1$. For medium high latitudes, $|\varphi| > 57^\circ 30'$, the 6° zone-width is less than 360 km, which means that Sweden will not benefit from this circumstance, i.e. the scale factor will never be $=1$. In the northern parts the scale factor will never be larger than 0.9998.

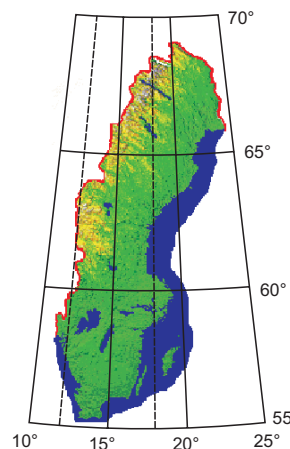

A New Map Projection

Universal Transverse Mercator (UTM)

The drawbacks of UTM may lead to the definition of a common European map projection. How could such a projection be defined?

- Gaussian projection
- Every degree is allowed as central meridian
- Scale reduction factor $=1$.

The advantages of an ETM are that every European country can choose their own central meridian or meridians. They just have to use whole degrees. If there is a need of several zones for large scale works 1° zones are suitable in southern Europe and 2° zones in northern parts like Sweden. For small-scale maps the zone width can be arbitrary and a set of coordinates would be unique if it is combined with the longitude of the central meridian.

European Transversal Mercator (ETM)?

The choice of map projection(s) as a part of the national geodetic infrastructure is depending on different needs. It is a main task for the National Mapping Agencies to make that choice based on the needs of different user applications e.g. large-scale mapping, cadastral works and topographical mapping.

Summary

An Equal Area Projection for Statistical Mapping in the EU - *Lysandros Tsoulos*

Background

A map is a plane-surface representation of a portion of the surface of the earth. Inasmuch as a spherical or spheroidal surface is non developable – that is, cannot be spread out or represented on a plane without more or less serious distortions or deformations – any map covering a considerable portion of the earth’s surface is not truly representative, but only an approximation of the earth’s features in their relative positions, sizes and shapes. In mapping any great extent of surface we meet with serious difficulties which will introduce departures from absolute representations.

The position of any point on the earth’s surface is definitely fixed in its proper latitude and longitude. The corresponding system of reference lines of latitude and longitude which constitutes the framework of the map, is known as the map projection. An infinite number of different map projections are theoretically possible. In most branches of cartography, notably in the preparation of large-scale maps, topographical maps and navigation charts, there is very little possibility of exercising any choice about the kind of projection to be used as the base for the map or chart. In other kinds of cartographic work, especially in atlas production, there is a greater freedom of choice in selecting a projection which is suitable for a map of a particular country or continent and for a particular purpose. In this paper we investigate the criteria and methods for the adoption of a suitable projection for Statistical mapping in the European Union.

The role of the zero dimension

The term *zero dimension* is used to describe “*the effective limit of what may be detected on a paper map with the naked eye, and which therefore represents a practical limit to uncertainty and errors in mapping, whether these arise from the original survey, or from the subsequent cartographic process, the influence of the map projection and subsequent cartometric work*” [Maling, 1989]. At the larger scales, map sheets cover a relatively small area, and although the projection distortions are present they are too small to be measured and thus they are smaller than the zero dimension. Common experience of making and using maps, sets the zero dimension at about 0.20 – 0.25 mm, which is the average size of the finest point which is visible to the naked eye of the map user.

Factors influencing the choice of a suitable projection

In the choice of a map projection, we must consider the properties most desired. As different projections have their own distinctive properties, and as certain properties are not necessarily exclusive but common to some of them, the exigencies of the problem at hand must generally be met by special study and, as a rule, that system of projection adopted will give the best results for the area under consideration.

It is fundamental principle of distortion theory that the particular scales, and therefore exaggeration, of areas and angles increase from the origin of the projection toward its edges. Since all projections have distortions of one kind or another and since, on a small-scale map showing a large portion of the world, these distortions can be measured, it is usually desirable to choose a projection in which distortion is tolerably small. Thus the primary aim of a logical choice is “*to select a projection in which the extreme distortions are smaller than would occur in any other projection used to map the same area*” [Maling, 1989]. The amount of distortion, which is likely to be encountered in a conventional map depends upon the location, size and shape of the area to be mapped. Distortion is least in the representation of a small, compact region and greatest in maps of the whole world. The three variables - location, size and shape - usually determine the choice of origin, aspect and class of a suitable projection.

The purpose of the map generally determines which special property is important. For example, if a conformal map of a region is needed, the way in which the area scale increases near the boundaries of the region must be studied and the conformal projection which shows the least exaggeration of area within the parts to be

mapped must be selected. If an equal-area map of the region is required, a similar evaluation of the angular deformation inherent to all equivalent projections must be carried out. If neither special property is essential, examination of both area scale and angular deformation must be made. This kind of evaluation suggests that the concept of minimum-error representation, is valuable in this context.

The preliminary stage in making the choice of a projection is to consider the location of the origin. In order to avoid excessive distortion within the area to be mapped, the point or line of zero distortion must be located near the center of it and the lines of zero distortion must be orientated to the longer axis through the region. This choice of origin and orientation of the lines automatically affects the aspect of the projection. The shape of the area to be mapped influences the choice whether it should be a point or line of zero distortion and this, in turn, determines the class of projection. Thus all three variables are intimately related and must be considered together.

Since any point on the earth's surface can be selected as the origin of a projection, it may be located at or near the center of the area to be shown on the map. The point of origin might be determined by computation, for example, as the center of gravity of the land mass, using the standard methods of calculating this for a plane figure shown by the outline of the country or continent on any convenient map. The method will only certainly locate the origin at a point which does not correspond to any graticule intersection required on the finished map. The choice has to be made whether to calculate the projection with reference to this origin or to select the graticule intersection nearest to this point as the origin. Using modern computing methods there is no really great problem either way. This might differ from the required center by as much as $2\frac{1}{2}^\circ$ in latitude and longitude. Usually the line of zero distortion is made to coincide with the longer axis through the country, or a pair of lines if the country is asymmetrical.

The choice to be made between the three classes of projections (cylindrical, conical and azimuthal) may be conveniently described in terms of *Young's Rule* (Figure 7), originally stated by Young (1920) and further extended by Ginzburg and Salmanova (1957). The principle arises from a basic idea that a region which is approximately circular in outline is better represented by means of one of the azimuthal projections, in which distortion increases radially in all directions, whereas an asymmetrical region is better mapped on a conical or cylindrical projection with lines of zero distortion.

Equal area representation implies that any portion of the map bears the same ratio to the region represented by it that any other portion does to its corresponding region. In thematic/atlas cartography the special property of equivalence is especially important for mapping statistical data.

The choice of origin, aspect and class of a projection

Equivalence, the property of equal-area representation

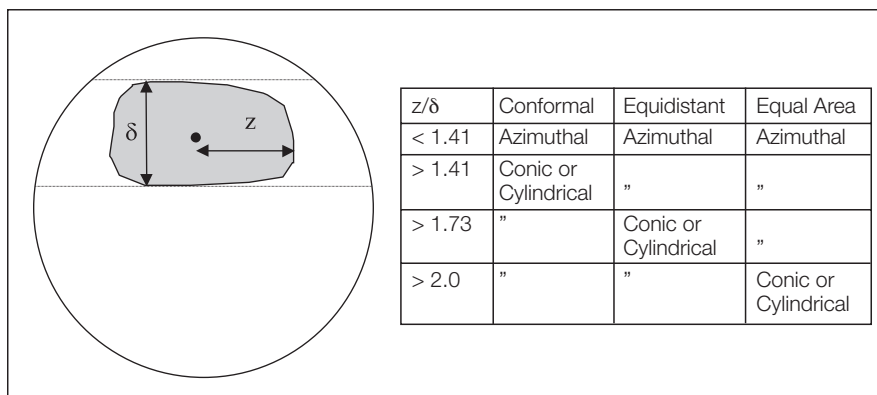

Figure 7: Young's Rule.

It is not entirely on account of the practical advantages of equal-area representation that this method of projection has acquired a popularity in atlas maps, but also on account to the fact that, in addition to this useful property, it is frequently possible to obtain a minimum scale error.

The projection to be used by EUROSTAT-GISCO

The projection to be used for the Reference Database of the European Commission (GISCO) digital cartographic products has to fulfil certain requirements. It has to:

- be suitable for a region like the European continent
- be equivalent in order to be used for portrayal of statistical data and
- preserve as much as possible the shape of the continent.

For the above mentioned reasons the Lambert Azimuthal Equal Area projection has been chosen. The parameters of this projection as it is applied on GISCO maps are:

Units	meters
Spheroid	sphere with radius 6,378,388 m
Parameters	
Longitude of the center of projection	09°00'00"
Latitude of the center of projection	48°00'00"
False easting	0.0 m
False northing	0.0 m

With the reunion of Germany and the expansion of the EU with three new member states (Austria, Finland and Sweden), the borders of the EU changed considerably and thus the parameters of this projection - as they applied for EU15 mapping - must be reconsidered.

The spherical assumption and the selection of the sphere

In cartographic applications, the scale limit for using the spherical assumption is taken to 1:5,000,000 or thereabouts (Maling 1989). The scale of GISCO maps is considerably smaller and thus the spherical assumption is acceptable. Special consideration must be given to maps covering individual countries as the scale for those maps varies. The choice of suitable size for the radius R of the sphere is critical. The simplest approach is to use one of the semi-axes of the reference ellipsoid. The equatorial radius of the spheroid, corresponds to the major axis a, so that the sphere is tangential to the spheroid at the equator. In the GISCO database the radius of the sphere is equal to 6378388 m. This equals to the major axis of the Hayford spheroid, which is used by the European datum (ED 50).

A better approximation is the radius of curvature of the spheroid for some reference latitude which is usually the center of the area to be mapped. The Gaussian radius of curvature - as it is called - can be calculated for the mean latitude φ_m of a zone formed by two meridians and two parallels. It is apparent that the size of the radius increases with the latitude.

The projection center

The expansion of the EU with three new member states (Austria, Finland and Sweden) and the future expansion with the EFTA countries and the Central European countries, requires the position of the projection center to a location where the projection distortions are kept to a minimum. Future expansion must be considered also and a decision must be taken on whether there will be a "temporary" or a "permanent" center. The area delimited by 25W – 45E and 32N – 72N includes all countries which might be EU member states at the foreseeable future. A simple but useful way of appraising the location of the origin of an azimuthal projection is to plot a series of concentric circles of radii z representing the isograms of maximum Angular Deformation and those of Scale Error at the scale of a convenient atlas map and to shift this overlay about on the map until a good fit is obtained between some of the extreme points of the area to be mapped (see Figures 8 and 9).

Projection: Azimuthal Equal Area
(Lambert)
Projection center: (9°, 53°)
Radius: 6384010

Scale: 1:25,000,000
Isograms of Maximum
Angular Deformation

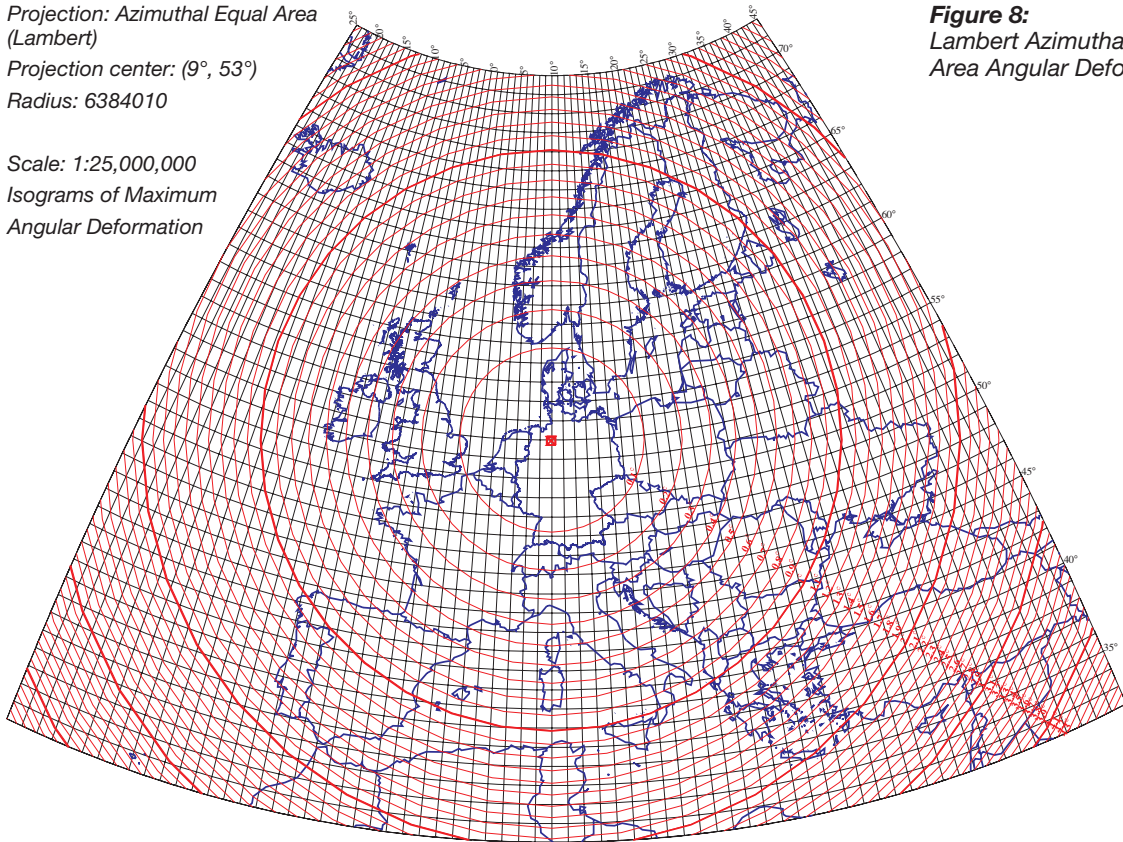

Figure 8:
Lambert Azimuthal Equal
Area Angular Deformation.

Projection: Azimuthal Equal Areas
(Lambert)
Projection center: (9°, 53°)
Radius: 6384010

Scale: 1:25,000,000
Isograms of
Scale Error [%]

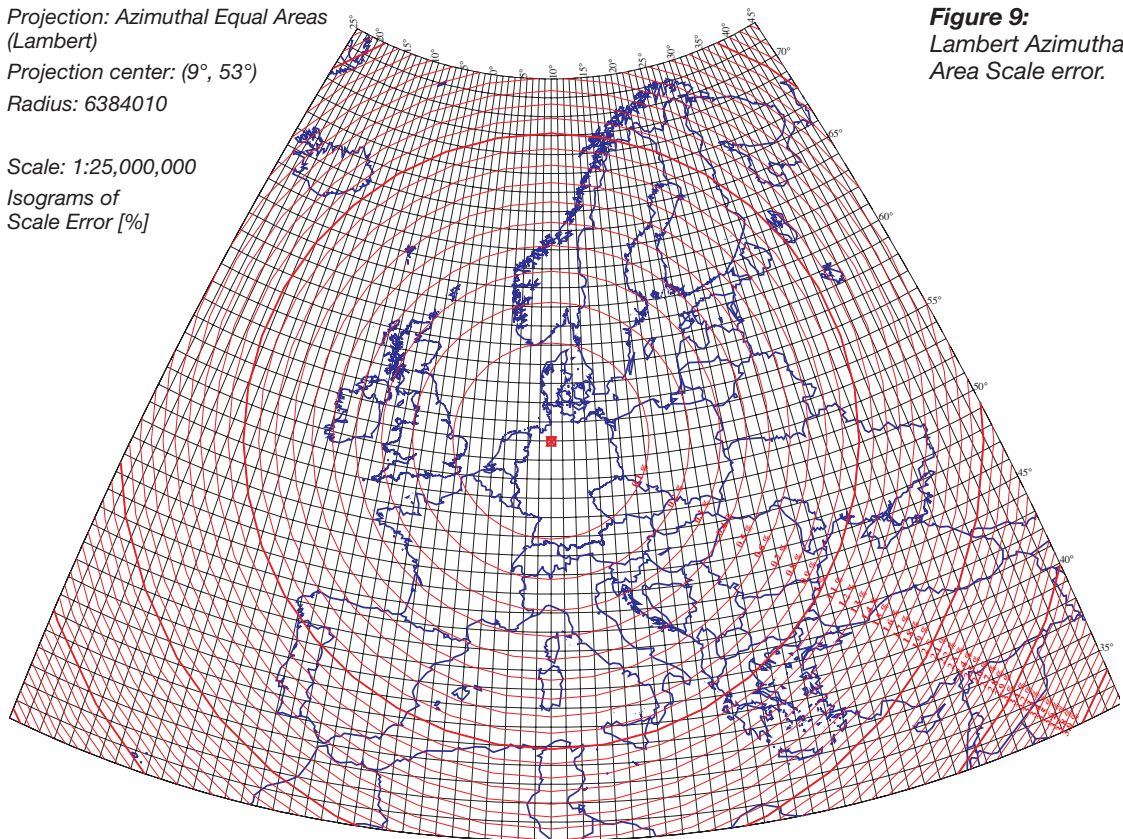

Figure 9:
Lambert Azimuthal Equal
Area Scale error.

Figure 10:
Albers Conical Equal Area
Angular Deformation.

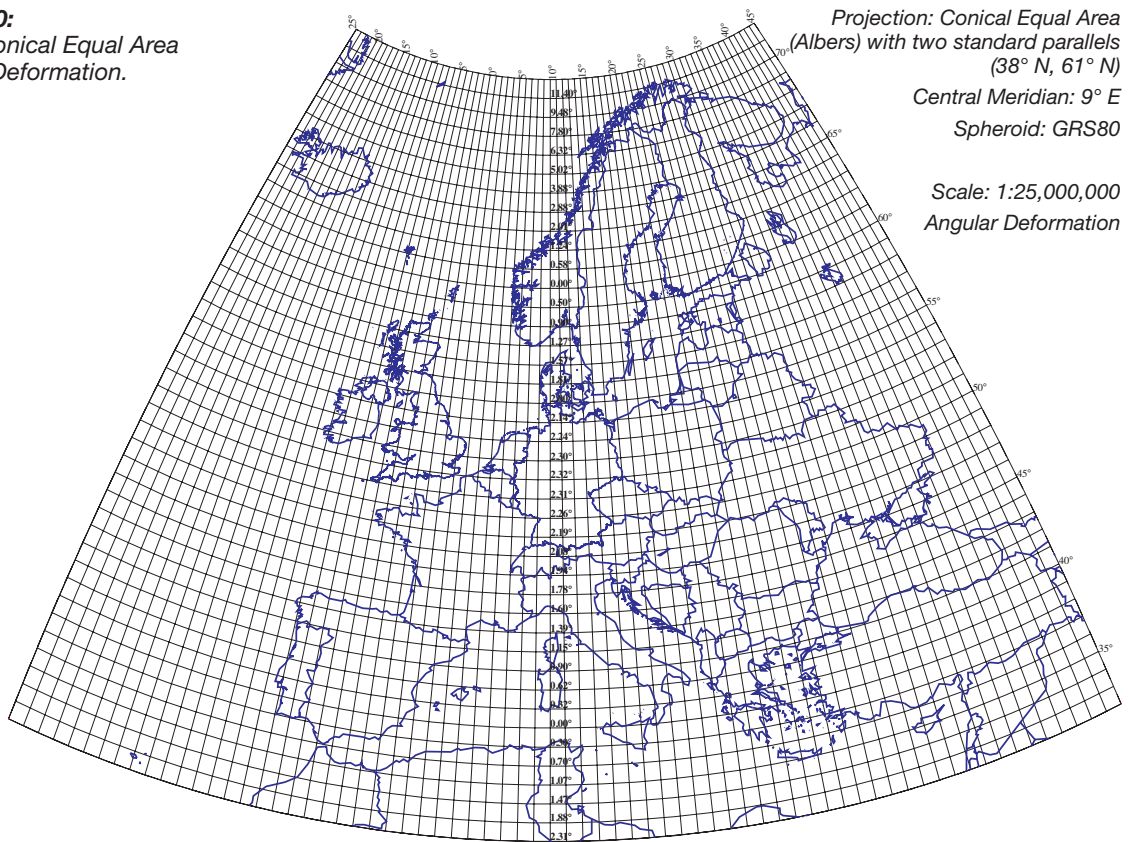
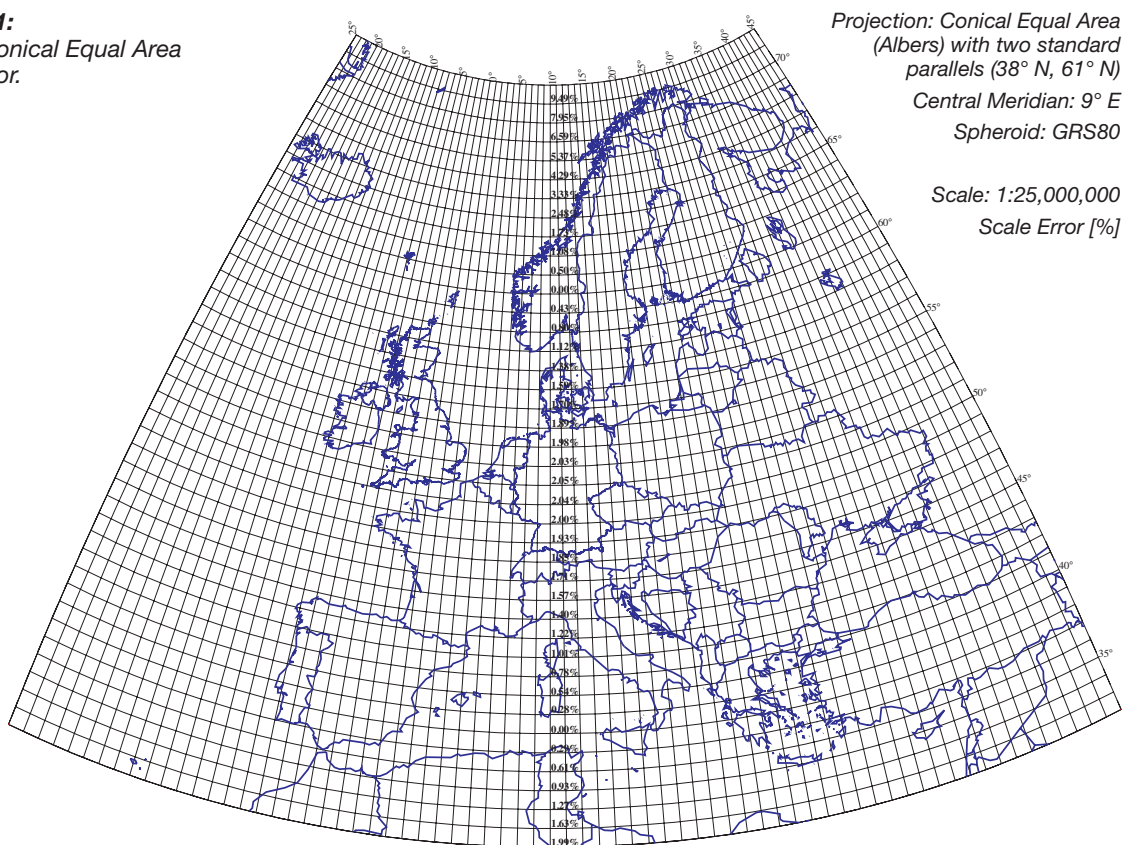

Figure 11:
Alberd Conical Equal Area
Scale error.



An alternative approach could be the Albers Equal Area projection for which the isograms of maximum Angular Deformation and Scale Error have been constructed (see Figures 10 and 11). As it is derived from the two pairs of maps, the distortions obtained at the extremities of the EU region on the Albers Equal Area projection, are larger compared to those obtained through the utilization of Lambert's Azimuthal Equal Area projection.

Based on the above, it is documented that the projection to be used for statistical mapping in the EU, is the Lambert's Azimuthal Equal Area projection. The projection center should be positioned at 9° E and 53° N. This is due to the fact, that the distribution of the distortions on the region is better than the one which may be obtained with either any other position of the projection center, or the Albers projection. Indeed, we have succeeded in keeping maximum angular deformation to 2° or less throughout the EU.

- [1] Briggs, D. and Mounsey, H. (1989): Integrating land resource data into a European geographical information system: practicalities and problems. *Appl. Geogr.*, 9, 5-20.
- [2] Frolov, Y.S. and Maling, D.H. (1969): The accuracy of area measurement by point counting techniques. *Cartogr. J.*, 6, 21-35.
- [3] Ginzburg, G.A. and Salmanova, T.D. (1957): *Atlas diya vybora kartograficheskikh proektsiy*. Trudy TsNIIGAiK, Vyp 110, Moscow, Geodezizdat.
- [4] Maling, D.H. (1968a): How long is a piece of string? *Cartogr. J.*, 5, 147-156.
- [5] Maling, D.H. (1989): *Measurements from Maps*, Oxford, Pergamon Press.
- [6] Snyder, J.P. (1985): *Computer-assisted Map Projection Research*. US Geological Survey Bulletin 1629, Washington, Government Printing Office.
- [7] Snyder, J.P. and Voxland, P.M. (1989): *An Album of Map Projections*. US Geological Survey Professional Paper 1453, Washington, Government Printing Office, 249 pp.
- [8] Young, A.E. (1920): *Some Investigations in the Theory of Map Projections*, London, Royal Geographical Society Technical Series No. 1, 76 pp.

This paper is the result of a study carried out in the framework of the Eurostat project "Social & Regional Statistics" Cartography Lot 5 [Contract # 8728003].

Conclusions

References

Acknowledgement

New Map Projections for Ireland - *Iain Greenway*

Background and context

Ordnance Survey Ireland (OSi) and the Ordnance Survey of Northern Ireland (OSNI) are the mapping organisations responsible for the surveying and mapping of Ireland and Northern Ireland. They are jointly responsible for the development of a geodetic framework on which all mapping is based. Without this common coordinate reference system, mapping on the island would not “fit together”.

The Global Positioning System (GPS) enables precise positioning anywhere on earth with a precision of a few millimetres, if an appropriate reference frame and positioning infrastructure is in place. This framework and infrastructure in Ireland is known as IRENET95, and is a precise realisation of the European Terrestrial Reference System, ETRS89, resulting in European Terrestrial Reference Frame, ETRF89, coordinates.

Mapping in Ireland, however, as in many places around the world, is based on a different geodetic datum from that used by the GPS. Although transformation formulae and parameters are available between Irish Grid and ETRS89, it is beneficial, particularly for GPS users, to associate a map projection with ETRS89. A projection allows three-dimensional ETRS89 coordinates to be converted to a two-dimensional form that can be plotted on a map. This maintains the quality and precision of GPS for surveying and mapping purposes, and simplifies GPS positioning on all Ordnance Survey mapping products.

Irish Grid coordinate system

The Irish Grid coordinate system, which is used by OSi and OSNI, is based on a rigorous adjustment of a carefully observed triangulation network, the origin of which dates back to the 19th century. The re-triangulation of Ireland and Northern Ireland in the 1950's and 1960's resulted in the Ireland 1965 datum from which latitude and longitude positions were computed in the Ireland 1975 (Mapping) Adjustment, on a modified Airy ellipsoid [1]. A Transverse Mercator projection was used to convert the latitudes and longitudes into 2-dimensional grid coordinates for mapping purposes.

The original parameters for the Irish Grid specified a scale factor of unity on the central meridian and applied to the Airy ellipsoid. Discovery of scale errors in the network resulted in the adoption of a scale factor of 1.000035 on the central meridian and introduction of the modified Airy ellipsoid to compensate. It is generally accepted that this scale factor is unusual (being greater than unity on the central meridian) and is partially due to shortcomings in measurement technology (including EDM equipment) at the time. Additional details and description of the datum and adjustment are contained in [1].

ETRS89 and IRENET95

With the advent of satellite positioning systems in the 1960's, and specifically the US Department of Defense's Global Positioning System (GPS) in the 1980's, techniques for determination of precise global positions were developed. These techniques are capable of improving positioning by a factor of 10 compared to traditional methods, and can expose the limitations of existing control networks. This is the case in Ireland.

With almost global coverage available, it is now possible to establish precise continental coordinate reference systems. One such is the European Terrestrial Reference System (ETRS), established by the International Association of Geodesy (IAG). This is realised by a network of permanently recording GPS stations, and can determine, on a daily basis, solutions of the positions of the permanent sites, including movement in their relative positions due to tectonic plate activity. The resulting apparent movement has brought about the need to time-stamp positions. The adopted European System is therefore fixed at the start of 1989 (1989.00) and is known as ETRS89.

In 1994, OSi and OSNI jointly agreed to establish a new geodetic control network in Ireland based on ETRS89. The scheme was largely observed during

1995 and 1996, and the resulting network is known as IRENET95. This network complies with international standards and provides high precision, distortion free control for GPS surveys.

In order to establish compatibility between ETRS89 and the Irish Grid, OSi and OSNI commissioned the Institute of Engineering Survey and Space Geodesy (IESSG) at the University of Nottingham to determine the most appropriate mathematical transformation. As a result of this, and further research, transformation parameters between Irish Grid and ETRS89 have now been determined [2].

Mathematical transformations cannot provide exact results; consequently they only partially realise compatibility between the Irish Grid and ETRS89. Applying a transformation to precisely surveyed positions results in distortion of the accurate GPS measurements to make them fit a less precise control network. It is more appropriate to maintain the accuracy of the survey by using mapping that is compatible with GPS, thus allowing surveys and mapping to be combined without the introduction of distortion. Therefore, to benefit fully from the accuracy achieved by IRENET95, both surveys and mapping should be based on this control network and datum.

Surveyors, engineers, navigators and a wide range of professional users, as well as the general public, increasingly use GPS. These users wish to be able to relate GPS positions to Ordnance Survey mapping unambiguously and quickly, without having to consider datum transformations, map projections, or the distortions inherent in the older mapping. It is therefore desirable that OSi and OSNI provide mapping that is compatible with GPS.

ETRS89 positions derived using IRENET95 controls are three-dimensional, in the form of Cartesian or geographical coordinates. However, because ETRS89 relates to a different geodetic datum than Irish Grid, it follows that the ETRS89 latitude and longitude of any point differ from the Irish Grid values. To calculate grid coordinates from latitude and longitude requires that a map projection is associated with the new geodetic framework, thus providing two-dimensional grid coordinates that can be shown on a map. However, the grid coordinate obtained is dependent on the ellipsoid and projection parameters used.

ETRS89 relates to the GRS80 ellipsoid [3], not the modified Airy ellipsoid used by the Irish Grid. By projecting onto different ellipsoids, different grid coordinates are obtained. However, the difference between the two sets of projected coordinates is only in the order of 55 m. This is not large enough to identify which ellipsoid was used, and as a consequence introduces confusion. It is therefore desirable to alter the projection parameters sufficiently to differentiate between the coordinates systems used. Introducing changes to any of the projection parameters provides an opportunity to address additional ambiguities in the projection, such as the modified scale on the central meridian.

The problem of making maps compatible with GPS is not specific to OSi and OSNI. A number of European National Mapping Agencies (NMA's) including Denmark, France, Switzerland, and Sweden have already introduced, or are actively considering, new projections to associate with ETRS89. The time is therefore ripe for the introduction of new map projections for Ireland to ensure full compatibility with GPS. This also provides an opportunity to address historic datum anomalies. The new projections need to be associated with the accepted global reference ellipsoid, GRS80, and associated coordinate system, ETRS89.

The projections adopted by OSi and OSNI must fulfil several criteria. They are intended to be GPS compatible, and therefore must be associated with ETRS89 and the GRS80 ellipsoid. They must also be orthomorphic or conformal (that is, preserving local shape), and they must minimise mapping distor-

The need for a new projection

Intended properties of the new projections

tion throughout Ireland and Northern Ireland. The projections should also be based on formulae that are readily available. Additionally, they must allow compatibility with current mapping to be maintained.

New projection options

The Transverse Mercator projection has been identified as the most suitable type of map projection by OSi and OSNI, for the following reasons:

- It is suitable for mapping areas where the north-south dimension is greater than the east-west dimension.
- It is conformal (or orthomorphic), and therefore the relative local angles about a point on the map are shown correctly. Also, the local scale around any one point is constant, and the shape of small features is maintained. Conformal projections are standard for most NMA's in Europe.

Mapping distortions caused by the projection are dependent on, and can be minimised by, the choice of suitable parameters. Therefore, the following three forms of Transverse Mercator projection have been considered:

- the current projection, Irish Grid (IG);
- Universal Transverse Mercator (UTM);
- a newly derived projection, Irish Transverse Mercator (ITM).

The projection parameters for the IG, UTM and ITM are listed in Table 5.

Table 5:
Projection parameters for the Irish Grid.

	Current		Proposed	
	IG		ITM	UTM
Reference Ellipsoid	Airy (modified)		GRS80	GRS 80
Central Meridian	8° West		8° West	9° West
Scale on CM	1.000 035		0.999 820	0.999 600
True Origin	Latitude (ϕ)	53° 30' North	53° 30' North	0° 00' North
	Longitude (λ)	8° 00' West	8° 00' West	9° 00' West
False Origin (metres)	200 000 W 250 000 S		600 000 W 750 000 S	500 000 W 0 S

Irish Grid (IG)

Originated as a classically derived Transverse Mercator projection, the IG was defined to meet the above criteria. The 1975 mapping adjustment resulted in alteration of the scale factor on the central meridian to 1.000035.

The parameters associated with IG are unsuitable for a proposed GPS mapping projection associated with the ETRS89 and the GRS80 ellipsoid. Applying these parameters, the difference between the projected ETRS89 and Irish Grid coordinate of a point is in the order of 55 metres. It is anticipated that this will introduce confusion regarding the coordinate system and projection used to derive any given point. Moreover, because of the adjusted scale factor on the central meridian, the effects of mapping distortions are not minimised.

UTM

UTM is an internationally recognised and widely available standard projection in mapping and GIS software. It was adopted in 1947 by the US Army, and used for military maps throughout the world. It divides the earth into sixty zones, between latitudes 84° North and 80° South. Each zone is 6° wide, with a scale factor of 0.9996 applied on the central meridian [4].

Ireland is situated in UTM Zone 29, which has a central meridian 9° West of Greenwich, resulting in a small part of Counties Antrim and Down in the east of Northern Ireland extending outside the nominal zone width boundary of 6° West of Greenwich. However, the zone width may be altered to meet local circumstances and since the UTM grid has a standard zone overlap of 40 km on either side of a zone boundary, all of Ireland can be contained within Zone 29.

Since the central meridian lies along the West Coast of Ireland, mapping distortions are not distributed evenly. Applying UTM to Ireland results in coordinates that have a 7-digit northing and 6-digit easting, compared to the current IG reference system, which has 6 digits in each.

ITM is a newly derived projection that may be associated with the ETRS89 and the GRS80 ellipsoid. The true origin and central meridian defined in the Irish Grid are maintained, thus distributing the distortions due to the projection evenly.

Consideration was given to the introduction of a scale factor of unity on the central meridian. However, using a scale of 0.99982 (see Appendix A) results in two standard parallels, and the magnitude and effects of scale change are minimised. The position of the false origin is moved to a point 600,000m west and 750,000m south of the true origin. This results in grid coordinates that are significantly different from IG, but does not introduce additional distortion or complexity. The magnitude of the shift ensures that IG coordinates plotted on the ITM projection do not fall on Ireland or Northern Ireland, and vice versa (see Figure 12).

ITM

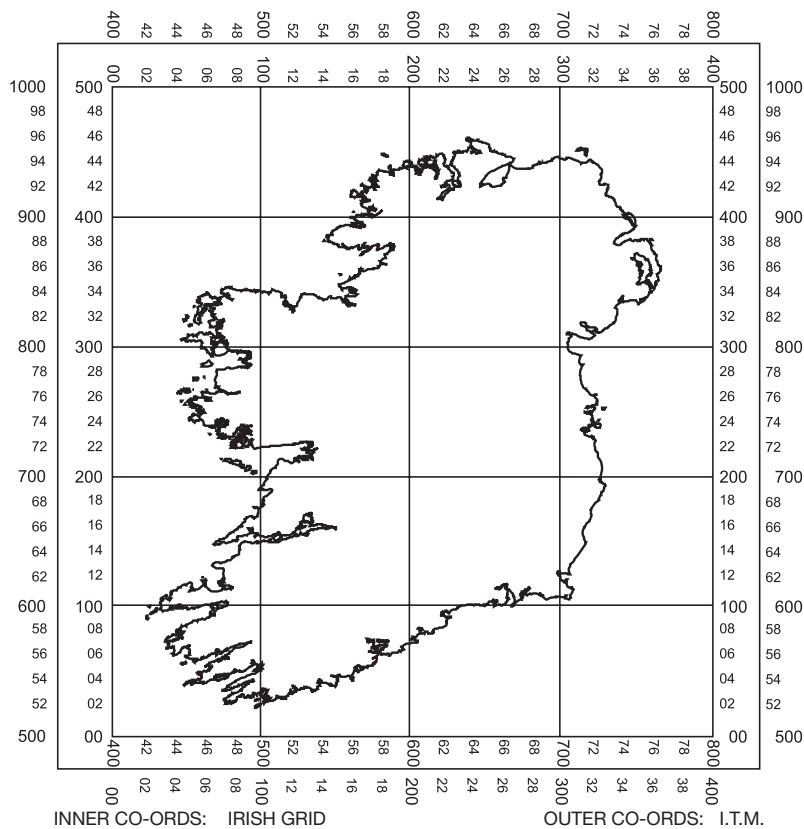

Figure 12: ITM and IG coordinates for Ireland (This diagram is illustrative only – the relationship between IG and ITM is not constant and varies over Ireland).

The effects of the three projections have been compared in relation to scale correction, area and convergence; figures are included in Appendix B.

Comparison of the proposed projections

For Transverse Mercator projections, scale correction is a function of grid distance from the central meridian. It is therefore constant for any given easting, and is independent of the northing.

Scale Correction

The range of scale correction resulting from both IG and ITM is 355 ppm, whilst UTM has a range of 659 ppm. However, IG does not have a standard parallel (where scale is unity). Although UTM has one standard parallel, the location of the central meridian results in larger scale corrections on the West Coast. Since ITM is secant and centred on Ireland, it provides two standard parallels (see Figure 13).

Area Currently all areas are computed by OSi and OSNI directly from the mapping (IG on the Airy modified ellipsoid), without applying scale corrections. Since all survey observations are reduced to the reference ellipsoid before being projected onto the mapping, changing the ellipsoid will introduce changes in the areas shown on maps.

To quantify the magnitude of the change, an area of one hectare (100m x 100m) on the current mapping was re-projected onto UTM and ITM. Applied to UTM, the largest change in area occurs on the central meridian at 9° West of Greenwich, and results in a decrease in area of 10.3 m² (0.1%) Similarly, the worst-case for the proposed ITM mapping system occurs on the ITM central meridian at 8° West of Greenwich, and results in a decrease in area of 1.7 m². Using the current IG projection parameters applied to the GRS80 ellipsoid results in an area increase of 2.4 m².

When using a 1:1,000 scale map it is only possible to plot to an accuracy of 20 cm, which results in a possible error in the area measurement of ±40 m². This is significantly greater than the area change resulting from a change in projection and therefore the effect on area measurements can be considered negligible.

Convergence IG and ITM both use the same true origin and central meridian, and therefore using ITM projection parameters does not affect convergence. Furthermore, the change in the size of the ellipsoid from the modified Airy to GRS80 is not large enough to affect the calculated convergence.

Adopting UTM implies a central meridian at 9° West, which results in an increase in convergence of between 47' and 50'. At the extremes of the projection this increases convergence from 2° 03' 39" to 2° 53' 08".

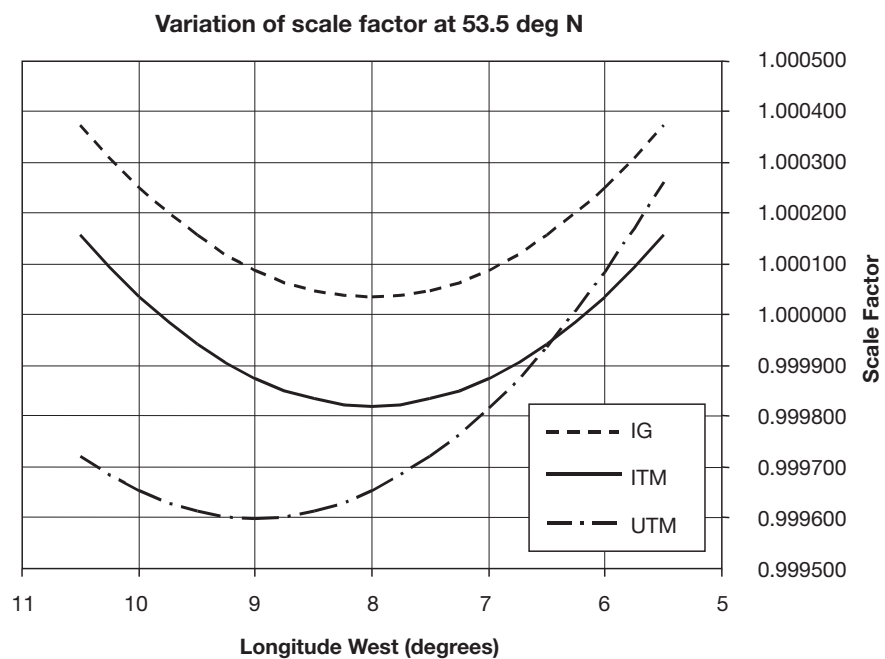

Figure 13: Variation of scale factor at 53° 30' N.

As described in previous sections, any new projections should minimise distortions within the new mapping system and realise ETRS89 coordinates that are substantially different from the existing corresponding Irish Grid coordinates (thus avoiding confusion). These criteria immediately rule out the possibility of maintaining the current projection parameters. However, both ITM and UTM will provide coordinates that are significantly different to IG.

With regard to scale correction, UTM produces the largest scale correction, of -400 ppm or 40 cm per km on the central meridian. This becomes significant when plotting measurements of greater than 500 m. UTM also provides the largest range of correction (659 ppm). The location of the standard parallel requires that corrections of greater than 200 ppm are applied to all observations west of a longitude of 7° west.

ITM, however, minimises and evenly distributes scale corrections, with a maximum scale correction of 180ppm on both the central meridian and the extremes of the projection. Positioning the central meridian in the centre of Ireland at 8° west also results in even distribution of convergence and t-T corrections.

The location of the UTM central meridian produces increases of 50' in the convergence calculated along the East Coast. The adoption of either UTM or ITM map projections has no significant effect on area measurements.

This paper has described the complexities introduced when attempting to make GPS measurements fit onto existing mapping. The growing numbers of GPS users, most of whom have no interest in issues such as transformations and adjustments, will therefore be best served by a mapping system which is fully compatible with GPS. There are, however, very many existing users of OSi and OSNI mapping. Many of these have associated their own data with the mapping data and therefore have significant databases using IG coordinates. There is substantial effort involved in converting these large databases into a different coordinate reference system. Any proposed change cannot ignore the needs of these users.

Whilst recognising that the majority of map data users in Ireland will not be concerned about the international compatibility of their work, there are important applications which will benefit significantly from such compatibility. Although UTM, for the reasons described, is not the ideal map projection when considering Ireland in isolation, it is an internationally recognised standard, and is likely to be adopted by the European Commission for its mapping needs.

Consequently, OSi and OSNI intend to adopt the following policy:

1. Adopt and offer a range of products and services using the ITM map projection with the above parameters to be associated with the ETRS89 coordinate reference system and the GRS80 reference ellipsoid.
2. Offer to their customers working in the international and European context the option to use data projected on UTM. This will provide a standardised international way in which grid coordinates can be expressed to ease integration and data exchange across Europe and beyond.
3. Continue to offer to their traditional map users the assured use and backward compatibility of IG products and services.

By using IRENET95 control, along with OSi and OSNI mapping projected in ITM or UTM, GPS surveys can be combined with national mapping while still maintaining survey accuracy and avoiding the current requirement to compute or apply transformations. It is further anticipated that the proposed new map projection, ITM, will simplify and encourage the use of GPS with OSi and OSNI products. Compatibility between the new projection and Irish Grid will be maintained using the derived transformations.

Use of ETRS89 requires that the GRS80 ellipsoid is used. Since the geoid in Ireland is not coincident with this ellipsoid, appropriate reductions must be applied when carrying out precise surveys. To further improve compatibility

of OSi and OSNI products with GPS, methods are currently being investigated to allow the determination of orthometric height using GPS.

Following the introduction of new map projections for Ireland, all mapping must include the appropriate labelling to identify the projection used. Changes to the map detail depicted will not be significant enough to allow simple visual identification; the grid coordinates, however, will provide an easy method of distinguishing the projection and grid used. Adoption of new projections for Ireland may also have subsequent effects on the map cataloguing systems for users.

Various issues remain to be resolved, with user input a vital part of that process. Decisions on the exact implementation details will therefore not be made until the middle of 2001. Key areas for further discussion include the timescale within which users can accommodate changes, the coordinate reference system to be used for small-scale maps, and how product design can be used to assist in the easy identification of the projection being used for any particular map.

References

- [1] Ordnance Survey Ireland, 1996. *The Irish Grid*. OSi, Dublin.
- [2] Ordnance Survey Ireland, Ordnance Survey of Northern Ireland, 1999. *Making Maps Compatible with GPS*. OSi, Dublin. OSNI, Belfast.
- [3] Moritz, H. 1980. *Geodetic Reference System 1980 (GRS80)*. Bulletin Géodésique vol. 54.
- [4] Snyder, J.P, 1987. *Map Projections-A Working Manual*, USGS paper 1395.

Appendix A - Calculation of Scale Factor on the Central Meridian for ITM

Scale factor is a function of distance from the central meridian. Therefore, scale factor at a point is dependent on the ellipsoid chosen and the location of the central meridian. The longitudinal extent of Ireland is from approximately 5° 25' to 10° 30' west of Greenwich. Minimum distortion will be achieved if the central meridian bisects these, i.e. at 7° 57' 30" west of Greenwich. Obviously, it is desirable to simplify the parameters involved in the projection; therefore, this was rounded to 8° west of Greenwich.

To select the scale factor on the central meridian three options are available:

1. maintain current scale factor of 1.000035
2. use a scale factor of unity
3. use a scale factor of less than unity, i.e. secant projection.

The third option produces two standard parallels and allows the magnitude of the scale corrections to be minimised throughout Ireland. Scale factor at a point is calculated from the formula:

$$F = F_0 [1 + P^2 \left(\frac{\cos^2 \varphi}{2} (1 + \eta^2) \right) + P^4 \left(\frac{\cos^4 \varphi}{24} (5 - 4 \tan^2 \varphi + 14 \eta^2 - 28 \tan^2 \varphi \eta^2) \right)]$$

Where:

- F is the scale factor at the point
- F₀ is the scale factor on the central meridian
- P is the difference in longitude between the point and the true origin.
- φ is the longitude of the point
- η is the longitudinal component of the deviation of the vertical,

and is derived from the formula:

$$\eta^2 = (v/\rho) - 1$$

Where:

- v is the radius of curvature of the ellipsoid perpendicular to the meridian, and is obtained from the formula:

$$v = a / (1 - e^2 \sin^2 \varphi)^{1/2}$$

- ρ is the radius of curvature of the ellipsoid along the meridian, and is obtained from the formula:

$$\rho = \nu(1 - e^2) / (1 - e^2 \sin^2 \varphi)$$

Where e^2 is the eccentricity.

Assuming a central meridian at 8° W, and a scale factor of unity on the central meridian, the maximum scale factor applying to Ireland was calculated as 1.000370 at approximately $10^\circ 30'$ W, $51^\circ 30'$ N, giving the range of required correction as 370 ppm.

Since the curve obtained from the above formula is symmetrical, the minimum magnitude of the required correction is obviously achieved by assuming a scale factor on the central meridian of $1 - 370 \text{ ppm}/2$, i.e. 0.999815. This was rounded to 0.99982 to simplify the parameters involved in the projection. This has the added benefit of moving the position of the standard parallels towards the central meridian and, due to the geography of Ireland, increases the land area where scale is unity.

Factors and assumptions in the calculation:

- the calculation is based on a central meridian at 8° W
- the central meridian does not correspond with the centre of the Island
- the exact point having the maximum scale factor was not identified
- the final figure was rounded to 5 decimals.

Scale Correction

	Current	Proposed	
	IG	ITM	UTM
Reference Ellipsoid	Airy Modified	GRS80	
Scale correction on west coast:	1.000 390	1.000 175	0.999 723
1) Over 100 m	+ 3.9 cm	+ 1.8 cm	- 2.8 cm
2) Over 1 km	+ 39.0 cm	+ 17.5 cm	- 27.7 cm
Plottable accuracy @ 1:1,000	20 cm	20 cm	20 cm
3) Max. Distance	0.5 km	1.2 km	0.7 km
Scale correction on Central Meridian:	1.000 035	0.999 820	0.999 600
4) Over 100 m	+ 0.4 cm	- 1.8 cm	- 4.0 cm
5) Over 1 km	+ 3.5 cm	- 18.0 cm	- 40.0 cm
Plottable accuracy @ 1:1,000	20 cm	20 cm	20 cm
6) Max. Distance	5.7 km	1.1 km	0.5 km
Scale correction on east coast:	1.000 377	1.000 162	1.000 259
1) Over 100 m	+ 3.8 cm	+ 1.6 cm	+ 2.6 cm
2) Over 1 km	+ 37.7 cm	+ 16.2 cm	+ 25.9 cm
Plottable accuracy @ 1:1,000	20 cm	20 cm	20 cm
3) Max. Distance	0.5 km	1.2 km	0.8 km
Range of scale correction:	355 ppm	355 ppm	659 ppm
Number of standard parallels in Ireland (where scale factor = zero):	0	2 721 269 E (ITM) 478 739 E (ITM)	1 680 550 E (UTM)

Appendix B - Comparison of Projection Types

Table 6:
Comparison of the effects of Scale Factor between the three projections.

Area Correction

Table 7 below shows a direct comparison between a current IG area measurement and the worst-case area differences in the ITM and UTM mapping systems:

	Current	Proposed	
	IG	ITM	UTM
Reference Ellipsoid	Airy Modified	GRS80	
Area (1 hectare):	10,000.0 m ²	9998.3 m ²	9989.7 m ²
Area difference from IG		- 1.7 m ²	- 10.3 m ²
Plottable accuracy @ 1:1,000	20 cm		
1) Best area measurement	9960.0 m ²		
2) Achievable accuracy	± 40.0 m ²		

Table 7:
Area Comparisons.

European Map Projections and Transformation Procedures. Experiences from the SABE Project - *H. Bennat, J. Brennecke, M. Duster, A. Illert, W. Mehlitz, I. Naumann*

Introduction

One important aid for the representation of spatial ground-related geoscientific data is their cartographic reproduction in thematic maps. Unfortunately, the maps are often based on different scales, reference systems, and projections, rendering comparison more difficult. This has proved a major obstacle in interdisciplinary work. As a consequence, the geoscientific world has called on cartographers to issue recommendations and guidelines for a single map projection to cover the widest possible range of uses and users. However, since the spherical shape of the Earth cannot be reproduced without distortion on a flat surface, it is impossible to produce only one map sufficient for all needs.

Map Projections

The various forms of projections can be categorized according to

the *type of the projection surface* in:

- azimuthal projections,
- cylindrical projections,
- conical projections,
- other analytic projections,

their *position in relation to the Earth's axis* in

- normal projections,
- transverse projections,
- oblique projections,

and according to the *characteristics of projection* in

- equidistant projections (for selected directions),
- equivalent projections, and
- conformal (orthomorphic) projections (in the differential sense).

For topographic mapping in Europe only conformal projections are used (see table 6) showing the great importance of navigational purposes and measuring tasks. The choice of the type of projection surface and position relative to the Earth's axis depends on the extent of a country. An area with large extent parallel to a meridian is well represented by a transverse cylindrical projection (i.e. Universal Transversal Mercator = UTM) while an area with a large West-East extent is better represented in a normal conical projection (i.e. Lambert Conformal Conical = LCC). For areas with a more or less equal extent in all directions a oblique azimuthal projection (center of the projection axis in the center of the area) is well suited.

These principles were used in traditional cartography by the National Mapping Agencies of Europe. With the increasing usage of GIS maps are losing their function to be a medium for information storage. With GIS technologies in the background maps are today only one form of information representation. This has opened the opportunity to store spatial information for archiving purposes in other map projections than for representation. By this we have to split the problem of choosing the optimum map projection. For objects described by points or lines (= a chain of points; vector data) geographic coordinates are ideally suited to store the spatial information in a GIS allowing for a flexible and rapid transformation into all possible map projections.

However, if we need a representation in form of a map the problem to determine the optimum map projection still exists. But for the EuroGeographics project SABE (*Seamless Administrative Boundaries of Europe*) we only deal with the storage of vector data.

SABE

SABE is a pan-European dataset which contains the geometry and semantics of the administrative hierarchies of 29 European countries. Each country has its own specific administrative hierarchy, composed of a different number of levels. The dataset includes:

- boundaries of administrative units,
- names of different levels in a administrative hierarchies and the relations between them,
- names and codes of administrative units in the national nomenclature, the unit's level in the EUROSTAT's classification for European Union countries (only versions 91 and 95).
- locations of residences of authorities of the units for the countries where the information exists.

In some countries, the coastal administrative areas extent into the sea. In some cases, the sea boundary is not defined or is defined in different precision to the other boundaries. For certain applications it is useful to link the statistical data to the land areas only. The SABE dataset is therefore provided with coastline information for the countries where the physical and administrative boundaries do not coincide.

SABE is delivered as individual country files which create a seamless and consistent dataset. The term consistent refers to the contents, to the structure, to geo-referencing, and time referencing of the data, although with so many independent data sources there are variations in the currency of the data. The term seamless means that there are no gaps or overlaps between polygons initially derived from different sources.

Figure 14 shows an example of three adjacent countries. The line thickness represents the different levels of administrative units.

The product is available filtered to two different geometric resolutions:

- 30 metres for applications at 1:100,000 scale
- 200 metres for applications at 1:1,000,000 scale

Both products contain the same attributes.

Coordinates are two-dimensional, geographicals in degrees (longitude, latitude) with decimal fraction.

The spatial reference system is WGS 84 (ETRF 89) with ellipsoid GRS 80.

No map projection is applied.

To be able to use SABE effectively with other datasets, you will need to ensure that the data have the same spatial reference.

The SABE 97 dataset covers the following countries:

Austria, Belgium, Croatia, Cyprus, Czech Republic, Denmark, Estonia, Finland, France, Germany, Great Britain, Hungary, Iceland, Ireland, Italy, Latvia,

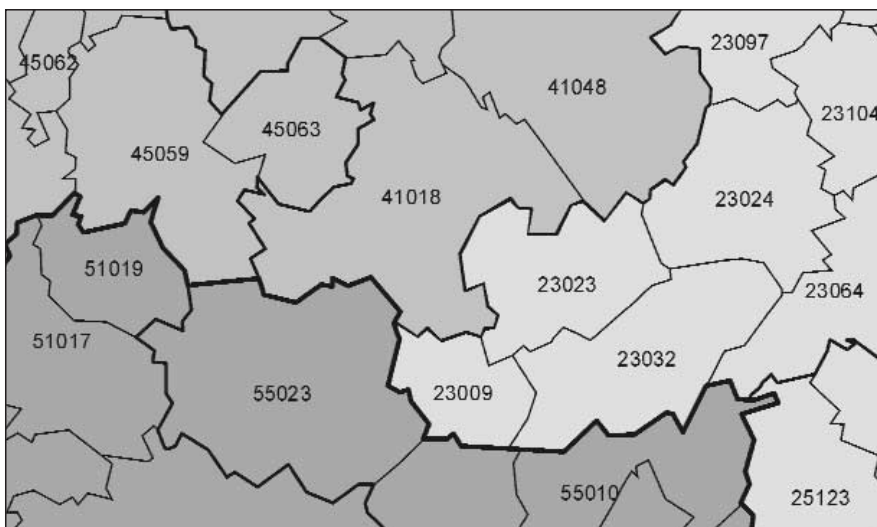

Figure 14:
Administrative boundaries
in a cross border area.

Figure 15:
Countries covered by
SABE97.



Liechtenstein, Lithuania, Luxembourg, The Netherlands, Northern Ireland, Norway, Poland, Portugal, Slovakia, Slovenia, Spain, Sweden, Switzerland.

Coastline is delivered for:

Croatia, Finland, Germany, Great Britain, Ireland, Northern Ireland, Norway, The Netherlands, Poland, Sweden.

Transformation Procedure

The SABE dataset is compiled from national administrative boundary datasets provided by national mapping agencies (NMAs). The source data are of the best available semantic quality.

The contributions have been transformed into a uniform structure and uniform positional reference system, line-filtered to a uniform resolution and are edge matched at international boundaries.

The transformation procedure from national map projections to geographic coordinates is part of the conversion procedure from national contribution to SABE data format which consists of 11 steps. The variety of map projections used by the NMAs is shown in Table 8.

1. Supply of update information
2. Conversion to ArcInfo format
3. Preprocessing: check national contribution for completeness with regard to the requirements of the SABE data model geometry: boundaries at the lowest administrative level, polygon structure, label point within each polygon semantic information (attributes): names, codes, hierarchy of administrative units, residence of authority, condominiums, exclaves etc. unique links between geometry (polygons) and attribute table (SHN, an attribute indicating to which administrative unit the area belongs).

4. Transformation of coordinates from national map projection to geographic coordinates referred to the national datum and national ellipsoid (parameters are given in Table 8).
5. Transformation of coordinates from national datum to WGS84 – parameters have to be supplied by NMAs.
 - geographical coordinates are transformed into rectangular coordinates X_1, Y_1, Z_1 referred to the national datum (parameters: a_n, b_n)
 - X_1, Y_1, Z_1 are transformed into rectangular coordinates X_2, Y_2, Z_2 by the respective national datum transition parameters:

$$X_2 = tX + sc (X_1 + Y_1 dZ - Z_1 dY)$$

$$Y_2 = tY + sc (-X_1 dZ + Y_1 + Z_1 dX)$$

$$Z_2 = tZ + sc (X_1 dY - Y_1 dX + Z_1)$$
 t: translation along X, Y, Z in m
 d: rotation around X, Y, Z in arcsec
 sc: scale factor ($sc = 10^6 sc' + 1$).
 - Finally X_2, Y_2, Z_2 is transformed into geographics based on the GRS-80 ellipsoid ($a = 6378137.000, b = 6356752.314$ m).
6. Processing of geometry to the SABE format (mosaic of lowest level administrative boundaries).
7. Processing of semantic information to the SABE data format (codes, names, administrative hierarchy, residence of authority, exclaves, condominiums).
8. Generalization to SABE30 geometric resolution (corresponding to map scale 1:100,000).

The MEGRIN Service Centre employed a combination of ArcInfo routines:

 - first step: eliminate polygons (if exclave, island) <1 ha = 10 000 m²
 - second step: line simplification/bend simplify, tolerance = 90 m
 - third step: line simplification/point remove, weed tolerance = 15 m

Generalisation is performed in Lambert cartographic projection, for metric system.
9. Processing of coastline to SABE data format.
10. Check routines: conformance with SABE data model
 - check if
 - no ANNOTATIONS exist
 - the precision is single
 - the FUZZY tolerance is set
 - full topology was built
 - no LABEL ERRORS exist, i.e. no polygon without label (centroid)
 - no DANGLE NODES exist, i.e. all arcs are elements of closed polygons
 - no polygons exist without plausible SHN and MOC (meaning of the centroid of the unit, ie. Mainland, exclave, water only, etc)
 - no “exclave” polygons exist without a “mainland” polygon
 - no two “mainland” polygons exist with the same SHN.
 - check SABE.ISN (administrative structure attributes table) and xx.NAM (name attribute table) for completeness and consistency of the hierarchical structure of the administration of country xx.
 - the hierarchical structure of the country is coded in SABE.ISN by pairs of structure - substructure codes, it can be retrieved completely from the lowest level (substructure code = 9997) to the highest level of the country
 - all unit types described in the xx.NAM have to be found in the SABE.ISN
 - the structure code found in xx.NAM fits to the structure of the respective SHN.
 - check if
 - each SHN is unique to the NAM table

- each SHN has the same length
- no SHN contains a “blank”
- each unit has a “proper name”
- each SHN found at a polygon can be found in the NAM table.

11. In case of inconsistencies: ask NMA for clarification.

One aim of the SABE project team is to get from the NMAs the data already transformed into geographical coordinates and WGS84 reference system.

Starting with a very small number of NMAs delivering this required format the number has increased from version to version. For SABE 97 about 50% of all NMAs provided us with the request format.

The minimum requirement with regard to map projections is to get a well documented dataset with all necessary parameters included. In the past only one third of the NMAs provided the SABE Service centre with a complete description of their national contributions.

The growing importance of this metadata is demonstrated by the increasing number of questions related to this theme from customers to BKG (Bundesamt für Kartographie und Geodäsie).

Table 8: Map projections used for SABE contributions.

Country	Projection Type after Graf et al. 1988	GeoRef-Cat (1996) (Scale, Mid Meridian, Projection Type)	Supplied for SABE 95 (Projection type and parameters see remarks)	SABE Transformation procedure
Austria	Transverse Mercator Projection	5000, 10000, 25000, 50000, 200 000 GK, MM 28,31,34° E (Ferro) 500000 LCC2	Transverse 6377397.155 6356078.963 1.0 13°20'00" 00°00'00" 300000.0 m -5000000.0 m	Arc/Info project
Belgium	Lambert Conformal Conic Projection	25000,50000 LCC2	Lambert 6378388.0 6356911.946 49°50'00" 51°10'00" 04°21'24.983" 50°47'58" 150000.0 m 165353.0 m	Arc/Info project
Croatia			Transverse units = 0.1 m, x shift = 248732.7 y shift = 491 293.0 ellipsoid = Bessel, 0.9997 16°30'00" 00°00'00" 2 500 350.0 m -14.0 m	Arc/Info project
Cyprus			Transverse TRANSVERSE 6378388.0 6356911.946 0.9996 33°00'00" 00°00'00" 500000.0 m 0 m	Arc/Info project
Czech Republic		25000, 50000, 100000, 200000 GK	Transverse	Special procedure
Denmark	Transverse Mercator Projection	25000,50000 UTM, MM 9°E (Gr)	UTM Zone 32	Arc/Info project

Country	Projection Type after Graf et al. 1988	GeoRef-Cat (1996) (Scale, Mid Meridian, Projection Type)	Supplied for SABE 95 (Projection type and parameters see remarks)	SABE Transformation procedure
Finland	Transverse Mercator Projection	5000,20000, 50000,100000 GK, MM 21,24,27,30° E (Greenwich)	Geographical Co-ordinates WGS84	Not necessary
France	Lambert Conformal Conic Projection	25000,50000,100000 LCC1 (4 Systems)	Geographical Co-ordinates WGS84	Not necessary
Germany	Transverse Mercator Projection	5000,25000,50000,100000,200000 GK, MM 6,9,12°E (Gr) ABL 25000,50000, 100000,200000 GK MM 9,15,21°E (GR) NBL 500000,1000000 LCC2	Geographical Co-ordinates WGS84	Not necessary
Great Britain	Transverse Mercator Projection	1000,2500,50000, 250000, TM, MM 8°W (GR)	Transverse 6377563.396 6356256.913 0.9996 -2°00'00" 49°00'00" 400000.0 m -100000.0 m	Arc/Info project
Hungary	Obligie Mercator Projection	1000, 2000, 4000, 10000, 25000, 50000, 100000 EOV (Egységes Országos Vetületi rendszer = National Projection system)	Obligie Mercator Projection	Special procedure
Iceland			Lambert 6378388.0 6356911.945 65°00'00" 65°00'00" -18°00'00" 65°00'00" -500000.0 m 500000.0 m	Arc/Info project
Ireland		64000, 127000, 570000 MM 8 °W 2500, 11000 500000,1000000 LCC2	(Transverse) Bonne (Transverse) Cassini 6377340.189 6356034.446 1.000035 -8°00'00" 53°30'00" 200000.0 m 250000.0 m Lambert Conformal Conic Projection	Arc/Info project
Italy	Transverse Mercator Projection	50000 UTM MM 9,15° E (GR) 100000 Gauss Bogoa, MM 9, 15°	Gauss Boaga (Conformal Cylindrical Projection)	Special procedure I
Latvia			Transverse 6378137.0 6356752.314 0.9996 24°00'00" 00°00'00" 500000.0 m 0.0 m	Arc/Info project
Lituania		600000 Ptolemy (Conformal Conic Projection)		Arc/Info project
Lichtenstein			Obligie Mercator Projection <i>see Switzerland</i>	Special procedure
Luxembourg	Transverse Mercator Projection	20000,50000, 100000 GK, MM 6°10' E (GR) 250000 LCC2	Transverse 6378388.000 6356911.946 1.0 06°10'00" 49°50'00" 80000.0 m 100000.0 m	Arc/Info project
Netherlands	Stereographic projection	10000,25000,50000, 100000 conformal Stereographic projection 250000 UTM		Special procedure

Country	Projection Type after Graf et al. 1988	GeoRef-Cat (1996) (Scale, Mid Meridian, Projection Type)	Supplied for SABE 95 (Projection type and parameters see remarks)	SABE Transformation procedure
Northern Ireland			Transverse 6377340.189 6356034.446 1.000035 -8°00'00" 53°30'00" 200000.0 m 250000.0 m	Arc/Info project
Norway	Transverse Mercator Projection	25000, 50000 UTM	UTM Zone 33	Arc/Info project
Poland	Transverse Mercator Projection	25000, 50000, 100000, 200000 GK	Transverse	Arc/Info project
Portugal	Transverse Mercator Projection		Transverse 6377397.155 6356078.963 0.001 -8°07'54.862" 39°40'00" 0.0 m 0.0 m	Arc/Info project
Slovakia			Transverse ellipsoid = WGS84 0.9996 21°00'00" 00°00'00" 500000.0 m 0.0 m	Arc/Info project
Slovenia		25000 GK, MM 15° E (GR)	Transverse 6377397.155 6356078.963 0.9999 14°59'47" 00°00'00" 500000.0 m - 5000000.0 m	Arc/Info project
Spain	Transverse Mercator Projection	25000, 50000 UTM	Geographical Co-ordinates WGS84	Not necessary
Sweden	Transverse Mercator Projection	10000, 20000, 50000, 100000, 250000, 1000000 GK MM 15°48'29",8 E (GR)	Transverse 6377397.155 6356078.963 1.0 15°48'29.8" 00°00'00" 1500000.0 m 0.0 m	Arc/Info project
Switzerland	Obligue Mercator Projection	25000, 50000, 100000, 200000, 300000, 500000, 1000000 Swiss Projection System	Obligue Mercator Projection	Special procedure

Remarks

Similar and related expressions

Transverse Mercator Projection

Transverse Cylindrical projection

Equatorial Cylindrical Projection

Conformal Cylindrical Projection

Gauss-Krüger

Universal Transverse Mercator (UTM)

Lambert Conformal Conic Projection

Lambert Conical Conformal

Conformal Conic Projection

Parameters for transformation to geographic coordinates: (destination ellipsoid is always the same)

- **TRANSVERSE** (Conformal cylindrical projection in transverse position):
 - large and small semi-axis of the source ellipsoid
 - scale factor on the central meridian
 - longitude of central meridian
 - latitude of the origin of northings
 - false easting
 - false northing.
- **LAMBERT** (Conformal conical projection in normal position):
 - large and small semi-axis of the source ellipsoid
 - latitude of southern standard parallel
 - latitude of northern standard parallel
 - longitude of the origin for eastings
 - latitude of the origin for northings
 - false easting
 - false northing.

Map Series/Organisation	Scale	Projection
NATO	50 000	UTM
JOG250	250 000	UTM(84°N – 80°S) UPS (North of 70°30 N)
M1404	500 000	Lambert Conformal Conic Projection
ONC	1 000 000	Lambert Conformal Conic Projection
International Map of the World 1:1,000,000 (IMW)	1 000 000	Lambert Conformal Conic Projection
Karta Mira	2 500 000	Conic Equidistant Projection
Tectonic Map of Europe 1:2.5 Mio	2 500 000	Lambert Conformal Conic Projection

Table 9:
*Map Projections of
International Map Series.*

- [1] Graf, Ch., D. Nüesch, E. Meier, U. Frei (1988): Map Projections for SAR Geocoding. ERS-D-TN-22910-A/9/88, DFVLR Technical Note.
- [2] GeoRef-Cat (1996): Katalog Europäischer Geodätischer/Kartographischer Bezugssysteme, Teil C – Kartenbezugssysteme. Bearbeitet vom CERCO Service Centre im Bundesamt für Kartographie und Geodäsie - BKG Frankfurt am Main, Germany Stand: 21.02.1996 (internal CERCO report).
- [3] Naumann, I. & Illert, A. (1998): SABE95 Report (internal report.to SABE members).
- [4] SABE User Guide Version 97 (www.megrin.org/SABE/ug97.pdf).
- [5] Sievers, J. & Bennat, H. (1989): Reference systems of maps and geographic information systems of Antarctica. Antarctic Science 1 (4): 351-362.

References

The Future of Coordinate Reference Systems - *Stefan A. Voser*

Introduction

The European Commission has already organised two workshops on coordinate reference systems. The first one held in November 1999 dealt with geodetic reference systems, the second one held in December 2000 dealt with map projections. This shows the importance of the topic not only for scientists, engineers, technologists, but also for users and politicians.

Coordinate reference systems are the mathematical fundamentals for geospatial management. Their integration into digital geomatic tools such as GIS and remote sensing tasks, navigation applications and computer-aided cartography is a must. And there is also an ongoing process on harmonisation, normalisation and coordination. [see e.g. Voser 1998, Voser 2000].

In the past, most of the different types of coordinate reference systems were treated separately, and only few experts were aware of the complexity of their handling and the relationships among them. A user of geospatial information was only confronted with the topic when making measurements from maps.

Nowadays, every user of digital geospatial information should be aware of coordinate reference systems, their importance for understanding coordinates describing geospatial locations as well as the handling of the coordinate reference system management. Here still is a big deficiency, and also its integration into geospatial tools is insufficient or not user-friendly, or the knowledge to identify the correct coordinate reference system instance makes problems due to missing information or knowledge.

Digital Geospatial Management (DGM)

Modern technologies have an increasing large influence into our daily life. It affects our (tele)communication as well as our focus, the geospatial management: navigation on the water, in the air and on land, the digital compilation of inventories about the landscape or the biodiversity, environmental data, social and economic patterns. Some overview about the wide spectrum is also found by the list of EC projects presented in [Annoni 2002]. All these geospatial management tasks require a large amount of models, knowledge, experience and tools.

The growing discipline of geomatics is covering more and more different, specifically traditional disciplines such as geodesy, cartography, geography, informatics, ecological and social disciplines as well as economic marketing strategies. Because of that, a lot of interdisciplinary teamwork is required to build up compatible national and international geodata infrastructures¹⁹. In summary, this part of digital geospatial management (DGM) is a complex field, influences the workflow to solve geospatial tasks, may affect a higher efficiency, but also requires a lot of investments.

A fundamental requirement that often gets forgotten herein is the complexity of a digital coordinate reference system management (dCRSM) which is part of a general coordinate reference system management.

Coordinate Reference System Management (CRSM)

Coordinate reference systems are an abstract construction to describe geospatial positions mathematically by coordinates. The mathematical construct is based on at least one coordinate system definition together with its geographic link to the Earth. This geographic relationship is given by the datum(s), describing the geometric fixation of the coordinate reference system on the Earth. Based on mathematical rules like the definition of metrics, different calculi to describe distances, angles, areas, volumes, directions etc. are derived by applying mathematical axioms and theorems. There exist a lot of coordinate reference system types and a much larger amount of instances. These facts make a rigorous coordinate reference system management (CRSM) indispensable.

The coordinate reference system management covers a very wide field of tasks to be solved. Its spectrum covers all topics of a general information management, including the use of digital tools and their standardisation. But

¹⁹ a geodata infrastructure includes, data, tools, distribution of data, knowledge, education, human resources, logistics, institutions and organisations.

more over, the definition of CRS entities as well as their physical or technical implementation such as the construction and upkeep of geodetic reference frames etc. belongs to the management.

It is based on the vision, its abstraction to a theory delivering the fundamentals and methods for defining, describing and handling of coordinate reference systems. The fundamentals are found in mathematics, analytical and differential geometry, and their geospatial implementation is strongly related to geodesy, physics, and sensor techniques, but also is an important subject in astronomy and navigation and all methods for capturing geospatial information.

Hereby, coordinate reference system instances (e.g. ETRS89, a national map projection) and their physical realisations with coordinate reference frames (physically fixed points) have to be defined and implemented geospatially. Because a lot of different CRS types and instances may coexist, the relationships between them have to be described. This includes geometrical formalisms which may be very complex, and in many cases these geometric formalisms even are unknown.

The current situation for the handling of coordinate reference systems still is far away of being comfortable for any user of geospatial data. There exist a lot of national systems (see e.g. [Voser 2000, Ihde et al. 2002]) and only few high-end tools currently support a CRSM based on a CRS-registry in combination with the required functionality and metadata. The user still has a CRS puzzle to solve, and one of the most current problems is the missing CRS assignment to the data. The users often do not know where to find it. Moreover, they don't understand the underlying concepts.

Since 1996, the MapRef-internet collection [Voser 2000] publishes a lot of required CRS information. The MapRef collection is built up individually by the author of this article, but the spirit was born by a project which was funded by the German Federal Agency for Nature Conservation (BfN) from 1994-1996 where the geometric homogenisation of various European geodata sets had to be solved (see e.g. [Voser 1995, Voser 1996]).

Based on the idealistic vision, MapRef became a very broadly and frequently used source to match already many of the European users' needs. It still needs that the software industry provides the required harmonised CRS infrastructure, and this not only for high end tools.

The European coordination for CRSM began to become public with the first EC Workshop in November 1999. Before, the topic was dealt only within expert circles like the geodetic initiatives on the establishment of the European Terrestrial Reference System 1989 (ETRS89) or the European Vertical GPS Reference Network (EUVN) [Annoni, Luzet 2000, p. 50f]. In the late nineties, various European countries began to adopt ETRS89 as their new geodetic reference system.

At the 1999 EC workshop [Annoni, Luzet 2000], it was recommended to adopt ETRS89 as the geodetic reference systems for projects within the EC and also to establish a public domain list of CRS parameters which isn't available yet. In the 2000 EC workshop [Annoni et al 2002], a set of new European projection instances are recommended at least for the EC needs.

Map Projections and spheroids are used to describe primarily horizontal position, whereas the height often is treated within different CRS systems. A connecting effort is also done by the geodetic community [Ihde et al. 2002, Ihde/Augath 2002a].

At a technical level, various efforts have already been made to include the CRS assignment to the datasets. Various high-end geomatic tools support this requirement; some data formats support such system assignments as well. Best known

Current situation of CRSM in Europe

therefore is the raster format GeoTIFF in which the CRS identity codes are based on the EPSG database. At standardisation level, the OpenGIS Consortium as well as ISO TC211 works on a semantical, technical and functional level to reach interoperability for CRSM. But an overall coordination is missing.

The User's need of CRSM

There is always a big gap between the experts and the users of spatial data. By the information technology and the increasing use of automated navigation and positioning tools as well as the increasing market for geospatial data, also coordinate reference systems and its management came into focus by public interests. In many cases, the user's needs for solving his problems can't be satisfied by the information or infrastructure the user has access to. In this case, the user's problems can mostly be solved by at least one of the following services:

- a centralised source for getting the missing information (e.g. the MapRef-Collection [Voser2000])
- a tool that manages the referencing problems
- a service he can request
- experts solving the referencing problems.

Coordinating CRSM Activities

The recent activities for a CRSM were embedded very little into an interdisciplinary network, and in many cases, these different efforts didn't neither know nor learn from each other. The CRSM network has to connect geodesy, cartography, GIS, geophysics, mathematics, geometry and application sciences (e.g. navigation, informatics...).

This network needs an information channel for all activities (science, education, industry, standardisation, authority bodies, service providers ...). These concepts e.g. may be found at the MapRef-Collection [Voser 2000], but it has to be embedded into a newly founded organisation. This organisation should become the regulatory and coordination body for the wide range of CRSM. It has to be discussed if this organisation only covers the European interest or already the world-wide interests. Next to the already discussed requirements, the following tasks and services should be covered:

- a library of historic and actual coordinate reference systems
 - definitions, metadata, responsibility etc.
 - identifying relations and their parameters between the different systems (including description of geodetic networks)
- a registry for coordinate reference systems
 - unique identifiers including harmonised naming conventions for CRS entities as well as for transformation methods and transformation parameters
 - quality controlling routines for CRS-services
- coordinating activities in research, science, tool development, user requirements and further more ...

Therefore a strong regulatory rule set has to be developed and the current developments at international standardisation level should be considered as well.

Conclusions

Coordinate reference systems are the mathematical and physical fundament to describe geospatial positions. In future, an even more intensive interdisciplinary coordination in the field of this topic is required to reach technical and automated interoperability.

An urgent need therefore is as next steps:

- designing & building up a CRS registry
- publication of and easy access to the collected CRS entities and their relations
- coordination of research, education and development
- Establishing platforms for education.

To follow these steps, the currently available solutions should be developed further on. One aim may be to expand the MapRef Collection in order to meet the user community quickly.

References

- [1] [Annoni, Luzet 2000] Annoni, A.; Luzet, C. (Eds.): Spatial Reference Systems for Europe; A joint initiative of Megrin and the Space Application Institute; Workshop 29-30 November 1999, Marne - La Vallée; Proceedings and Recommendations; European Commission EUR 19575 en, 2000.
- [2] [Annoni et al. 2002] current proceedings.
- [3] [Annoni 2002] Annoni, A.; Delince, J.; Wirthman, A.; Steenmans, C.: The EC requirements in Terms of Projection Systems – User Perspective and Problem Statement; in [Annoni, Luzet 2001].
- [4] [EPSG] European Petroleum Surveying Group at <http://www.epsg.org/>.
- [5] [EUREF] EUREF, the subcommittee for Europe of the IAG's Commission X on Global and Regional Geodetic Networks. <http://www.euref-iag.org/>.
- [6] [GeoTIFF] The GeoTIFF Raster Format at <http://www.remotesensing.org/geotiff/geotiff.html>.
- [7] [Ihde et al. 2002] Ihde, J.; Luthardt, J. Coordinate Reference Systems used in Europe - Including Map Projections. In [Annoni et al. 2002].
- [8] [Ihde/Augath 2002a] Ihde, J.; Augath, W.; The Vertical Reference System for Europe; In [Annoni et al. 2002].
- [9] [ISO TC211] ISO Technical Committee 211, Geographic Information/Geomatics; <http://www.statkart.no/isotc211/>.
- [10] [MapRef] The MapRef Collection, at <http://www.mapref.org>, since 1996.
- [11] [OGC] OpenGIS Consortium at <http://www.opengis.org/>.
- [12] [Voser 1995] Voser, S.A.; Datenaustausch zwischen Geo-Informationssystemen - Abbildung zwischen zwei Datenmodellen auf konzeptioneller und logischer Ebene ("Data Exchange Between GIS - Mapping Beyond Two Data Models at Conceptual and Logical Level"); 3. Deutsche Arc/Info-Anwenderkonferenz, März 1995.
- [13] [Voser 1996] Voser S.A.: Anforderungen an die Geometrie zur gemeinsamen Nutzung unterschiedlicher Datenquellen ("Geometric Requirements to Shared Usage of Geospatial Datasets from Different Sources"); 4. deutsche Arc/Info-Anwenderkonferenz, März 1996.
- [14] [Voser 1997] Voser S.A.: Anforderungen an ein modernes Georeferenzierungstool am Beispiel der Arc/Info-Applikation BEZUG. ("Requirements For A Modern Georeferencing Tool, Discussed on the Arc/Info application BEZUG"); 5. deutsche Arc/Info-Anwenderkonferenz, März 1997.
- [15] [Voser 1998] Voser S.A.: Schritte für ein automatisiertes Koordinatensystemmanagement in GIS und Kartographie ("Steps Towards an Automated Coordinate System Management in GIS and Cartography"). In: Nachrichten aus dem Karten- und Vermessungswesen, Reihe I, Heft Nr. 118, S. 111-125., Frankfurt am Main, 1998.
- [16] [Voser 2000] Voser, S.A.: The Internet Collection of Map Projections and Reference Systems for Europe; in [Annoni, Luzet 2000].

Identification, documentation and classification of map projections - *Peter Mekenkamp*

Introduction

In the field of cartography and GIS there is a growing pressure to pay close attention to more systematic use of projection methods for several purposes (P.G.M. Mekenkamp in “*The need for projection parameters in a GIS environment, EGIS/Amsterdam 1990*). Now - ten years later - nothing seems to have changed. Though Open GIS is described as transparent access to heterogeneous geodata in a networked environment, communication and integration still fails because of the missing parameters. Cartographic databases are being produced according to many different projection- and coordinate systems. The concept for documenting projections, as suggested in 1990 at the Utrecht University, is still to be recommended. This year further research has been done into the perceptible difference in deformation on small scale maps related to different projection systems. In a case study by Elger Heere and Martijn Storms at Utrecht University more than twenty different projections have been compared, using specially developed accuracy assessment software”.

Identification

Speaking about the identification of map projections, for most GIS users the reaction to this issue is: *impossible*. Recognizing the mathematics behind the map-image is very difficult and for most of the users impossible, because of the very complex theory of distortion.

To handle this problem two different solutions can be thought of:

- Adding map projection parameters to each map (metadata)
- Using a sophisticated method to recognize the projection through its distortion pattern.

Classification

Using, identification and recognizing map projections cannot be done without a good classification. In the past, projection methods have been developed by several scientists as a simple translation/transition of parallels and meridians to a flat surface.

From the knowledge that meridians are great circles and that parallels are small circles and perpendicular to the meridians, the idea was to create a projected graticule by means of a - easy to construct - method leading to (if possible) straight lines and concentric circles.

Until the introduction of computers the use of projection methods for small scale mapping was very much influenced by the simplicity of design and construction. The introduction of the cone and the cylinder, being intermedia between the curved globe and the flat plane, was a logic step in finding structure in a method of classification.

Now we have to realise that the choice for simplicity determined our choice for a classification method that is not geared to the present needs and possibilities. Our network of longitude and latitude lines superimposed on its surface (established by Claudius Ptolemy about A.D. 150) still determines our way of looking at the face of the earth. Our map projection classification is a direct result of that way of looking. Mapmakers planning to display a part of the Earths surface usually follow strict rules as a consequence of that old choice.

Rules for choosing a map projection

The *location of the area* to be mapped still appears to have great influence on the choice:

- as a matter of course we choose an azimuthal projection for the Pole area;
- areas around the Equator will usually be mapped using a cylindrical projection;
- countries like France or Hungary should be mapped, according to their latitude, using a conical projection.

The *extent (size and direction) of the area* related to the graticule often influences the choice. The well-known example of Chili (South America) shows the *decisive* role the extent an area can have on the projection choice. For this

Location	Extent	AZIMUTHAL			CYLINDRICAL			CONICAL		
		normal	transv.	oblique	normal	transv.	oblique	normal	transv.	oblique
Polar area $\varphi > 70^\circ$		v								
Area $20^\circ < \varphi < 70^\circ$	round			v						
	north-south					v				
	east-west							v		
Equator area $-20^\circ < \varphi < 20^\circ$					v					

country a *transverse* cylinder projection seems rather obvious. In general it can be established, that the *extent* of the area is *subsidiary* to the *location* of the area. The rarely occurring oblique cylinder and the oblique and transverse cone, which never occur in the field of cartography, are direct consequences of this.

Where the location and the extent of an area follow the classification according to the azimuthal, cone, and cylindrical approach, the *purpose of a map* follows a subsidiary classification in respectively conformal, equivalent and equidistant.

For example the map maker wants to display as well as possible:

- the position of points in relation to a given point or line. Though no map projection shows correct scale throughout the entire map, there are usually one or more lines along which the scale remains true. Projections showing true scale between one or two points and every point on the map are called: equidistant
- distribution of certain phenomenon within an area. any map projections are designed to be *equal-area* (or equivalent), so that a shape of a certain size covers exactly the same area of the actual Earth as a shape of the same size on any other part of the map
- the shape of the area throughout the map. Map projections showing relative local angles correctly at about every point on the map are called *conformal* (conformality applies to a point or infinitesimal basis)
- the shortest routes between points on the actual Earth (orthodromes or geodesics) as straight lines throughout the map
- the lines of constant direction on the sphere (loxodromes or rumb lines) as straight lines throughout the map.

In the most recent decade, computers have had substantial influence on the methods of map making. Through these developments, maps, as a *means of communication* have become more flexible. Digital spatial coordinate data can be tuned to the desired communication purpose faster and more completely. One consequence of this is that maps, as a two-dimensional analog end-product, have less the character of a multi-functional document. The increasing preference is for *more* maps, having a single purpose (mono thematic maps), over one map showing some or many aspects of physical or human geography (synthetic thematic maps). Viewed in this light, a systematic way of handling the problems of projection-choices is very desirable. The cartographic data interchange, which is part of Geographical Information Systems, emphasizes this call.

The I.P.D.S. (Integrated Projection Design System) software, developed at the Utrecht University, shows a simple way of approaching the problem of choosing the right map projection. The GIS-user has to give answers to two questions:

- What is the extent of the area?
- What is the purpose of the map?

Three alternatives are available for answering the first question. The map maker looks at the area (by preference on a globe) and decides to define the area as a:

1. one-point area,
2. two-points area,
3. three-points area.

New developments

Extent of the area

One-point area is an area a map maker chooses if:

- the area he deals with can be characterised as “round”, extending equally in all directions;
- a particular point on the Earth's surface must be represented as centre on the map:
 - related to a function (distances): airport, transmitting-station or satellite position;
 - related to topical events: locations or countries, in the news worldwide.

Two-points area is an area a map maker chooses if:

- the area he deals with can be characterised as rectangular
- two points must be represented concerning some relation of those points. For example: the trip of a head of state... or topical relations between two countries.

Three-points area is an area a map maker chooses if:

- the area he deals with can be characterised as “triangular”.

One-, two- or three-points-areas must be defined by as many geographical pairs of coordinates. The program leads automatically, in case of a one-point area, to an *oblique* azimuthal projection. Then the centre of projection is the chosen centre of the one-point area. In case two points are chosen, the program calculates a cylinder tangent to the circle through these points. If three points are defined, then the program calculates a cone tangent to the circle through these three points. For further applications it might be possible for programs to calculate an *intersecting* plane, cylinder or cone from the defined width of an area.

Purpose of the map

By optimising the projection choice in relation to the extent of the area, it is rather easy to find a suitable projection for each purpose. In the program there is a conformal, a equivalent and a equidistant projection for each of the different areas. According to this procedure, functional relations between data and location are represented better than before. For the cartographer it is important to know that the projection of every map is very much related to its purpose.

Area/purpose	AZIMUTHAL			CYLINDRICAL			CONICAL		
	normal	transv.	oblique	normal	transv.	oblique	normal	transv.	oblique
One point area			v						
Two points area						v			
Three points area									v

Classification parameters

The parameters, which should be mentioned on every analogue map document in the legend or as metadata in the digital database are:

- the area-code: 1, 2 or 3
- geographical sphere coordinates: (φ , λ)
- the width of the area: d (km)
- qualification: CON/EQV/EQD/GNO/ORT.

Knowing the standard projections, every mapping program can transform the coded images into every other projection, necessary for a better geodata integration.

Projection Accuracy Analyses

Since Nicolas Auguste Tissot in 1859 and 1881 published his classic analysis of the distortion which occurs on a map projection and since Eduard Imhof introduced his deformation grid (“Verzerrungs-gitter”) in 1939, there has been hardly any scientific development regarding the metric interpretation.

The Area-purpose approach for the classification of map projection



Conformal Stereographic



Equivalent Lambert



Equidistant Postel



Gnomonic



Orthographic



Conformal Mercator



Equivalent Sanson Flamsteed



Equivalent Lambert



Robinson



Equidistant plate carree



Equidistant half carree



Gnomonic cylindrical



Miller



Mollweide



Eckert I



Conformal Lambert-Gauss



Equivalent Albers



Equidistant Ptolemy



Bonne



Hammer

Figure 16:
Accuracy analysis
Gnomonic projection for
Europe

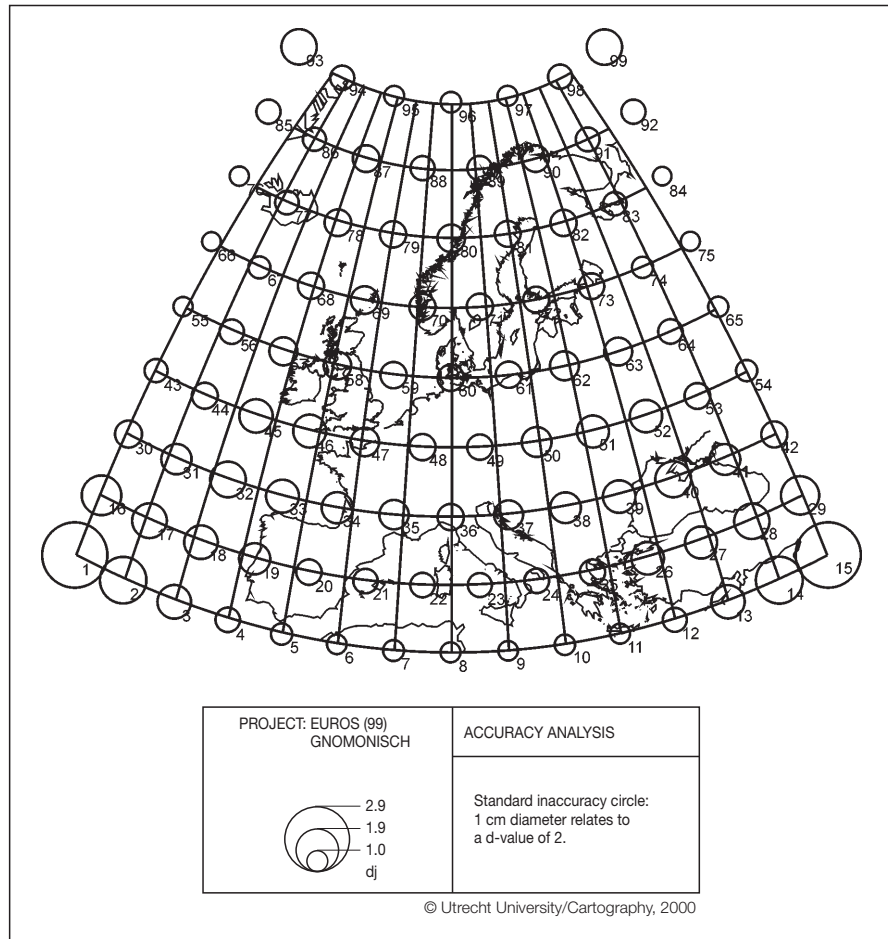

A logical step in deriving accuracy values for maps or images is to compare distances on the map or image with corresponding correct distances on the earth surface.

The relative position inaccuracy of two points can be determined by the difference that is found in this comparison related to the image scale. This scale is a weak point, because we cannot define it before having searched the whole image. In many small metric tests of several researchers the scale is regarded as constant, which is certainly not correct. The only way to find a usable image scale is to divide the total length of all distances measured on the image by the total length of corresponding distances on the earth surface. For this we need as many points as possible of which the coordinates are known in both image and global coordinate systems.

By means of spherical trigonometry it is easy to calculate great circle distances (b) on the globe from these world coordinates. Corresponding distances on the image (a) can be computed by first digitising all (n) points within a local rectangular coordinate system. We then find a mean scale (f) for the image as a whole. The distances a and b can be stored in matrices (or tables of distances) respectively A and B.

To allow the comparison of image distances with corresponding correct distances on the earth's surface, one has to have equivalence. This means that the distances of matrix B must be adjusted to the image scale f. This can be achieved by multiplying each distance b by the factor f. In matrix notation:

$$B' = f * B$$

The comparison of equivalent and corresponding distances is actually realised by finding the difference between the values of both matrices A and B'. For this we calculate a new "distance deformation" matrix:

$$C' = A - B$$

By taking the absolute value of each term we find matrix C. Each deformation value can be computed into a percentage deformation for every distance. In matrix notation:

$$H = 100 * C/B'$$

These absolute deformation values can be regarded as relative accuracy values between points. To find absolute values to indicate point accuracy, we take the sum of the square percentage deformations of distances related to one point:

$$[g_i] = [h_{ij}^2] * I_i$$

and subsequently find for every chosen point a point inaccuracy value in column matrix D through:

$$[d_i] = [\sqrt{g_i}/(n-1)]$$

These dimensionless values are called point inaccuracy values or d-values. Thus we can describe the accuracy of an image through point values found by means of absolute deformation between digitised points.

In order to get an interpretable indication of the accuracy of an image, the d-values can be visualised by circles the radii of which are proportional to their values. The circles are called *standard inaccuracy circles*. This method for accuracy analysis is therefore called the *circle method*.

Applying this circle method to the 20 different projections for Europe we see, that the *azimuthal projections* (especially the Lambert equal area and Postel equidistant) give the lowest mean d-value, meaning that these are the best projections regarding the scale variation in the Europe map.

The use of projections in modern cartography is not geared to the present needs. Finding a good projection still causes the map maker a good deal of time and trouble.

Information on maps, regarding map projection applied, is poor, incomplete and seldom appropriate for calculations.

It is possible to apply a few map projections efficiently for each area to be mapped. Standardization of projection will lead to better understanding of maps and to better and more efficient exchange of cartographic data (especially in GIS).

Applying the concept described here gives cartography a new practical instrument for optimising geometric communication.

Conclusions

A unique European cartographic projection system. Can it really not be proposed? - *Manfred Oster*

Current situation in Europe

In the invitation to this workshop there is the following remarkable statement: “A unique European cartographic projection system cannot be proposed”. After thinking over this statement which is the central focus of this workshop it seemed more suitable for me to put a question mark behind this statement. Can it really not be proposed?

I would not insist on making any difference between cartographic or geographic projection systems. As in German literature normally the term *cartographic* projection is used I would like to stick to this term meaning the same as geographic projection system.

If we consider the current situation in Europe we have to admit that the situation seems rather discouraging: According to a survey of the situation in Europe (Grothenn 1994) we have 5 different types of reference ellipsoids and 8 different types of cartographic projections used in the 37 different CERCO member or observer countries. How could they agree on one single projection system and which one should be selected? Which member countries would be able to afford the costs for changing their system?

The Spatial Reference System ETRS89 as basis towards a unique cartographic projection

Nevertheless one first and important step towards a unique cartographic projection system was made by defining a unique Spatial Reference System ETRS89 as the geodetic datum for geo-referenced coordinates which was adopted at the last Megrin workshop in November 1999. In Germany the Surveying and Mapping Agencies (SMA) already decided in favour of the ETRS in 1991. If we follow the logic behind this common European spatial reference system we have to ask ourselves: Would it not be the consistent to continue this process by aiming at a common cartographic projection? The spatial reference system always has been the basic precondition for producing maps. If we take into consideration that we are not only speaking about traditional maps but also about modern object oriented vector data we can extend our problem to topographic data in general. So, if we mention topographic data it implies both maps (also in raster form) and object oriented vector data representing a Digital Landscape Model (DLM).

Two levels of using a common projection system

We have to specify the different levels of using a common projection system:

1. Using a common coordinate grid but keeping the traditional sheet lines
2. Harmonising the sheet lines to cross border map series

What are the advantages of a unique projection system?

The first level mainly concerns the map consumer. A common coordinate grid provides a standard coordinate system for all member states without any risk of confusion. Before all for instance for cross border rescue mission an error of mixing up different coordinate systems could be fatal. Also if we consider the chances of commercialising raster or vector data: Any possible customer would be deterred to buy cross border data if he had to take care himself to harmonise the coordinate system in the first place before matching them together.

The second level mainly concerns the map producer. Up to now we still maintain our traditional aerial coverage in the border region without any further mutual coordination. Of course, there is an exchange of topographic data between neighbouring countries of the EU member states. But there is also a lot of double coverage of the border regions without any consideration that a harmonised sheet line system could avoid all double coverage. Thus, wasting tax payer's money on maintaining and updating thousands of square kilometres of double coverage in the different map series could be avoided.

If we discuss the aspects of a unique cartographic projection system this is not an objective for a middle or long term future but it is already a reality at least for those CERCO Members which are integrated into the western alliance NATO. According to our German military services a common UTM 6° grid

projection system for military map series in the map scales 1:50,000 to 1:1 Mio was realised from 1995 to 1998. I suppose that these standards for German military maps are relevant also in the other NATO member states of the western alliance. We can state that a change to a new system also for the civil map series does not represent any unusual challenge: We would only have to follow the example of the military map series.

Furthermore, in Germany a change from one projection system to another does not represent a totally unknown problem: in Germany changes in its cartographic projection system occurred three times during the last 100 years. The first change took place when we shifted from the original Prussian Polyeder Projection to the Gauß-Krüger-Projection. The second change was a consequence of the German reunification of 1990 when the Russian influenced map series in Eastern Germany had to be harmonised with the Gauss-Krüger (Bessel) projection system of Western Germany. The third change is still going on where the traditional German 3° Gauß-Krüger-Projection System is changed to the international 6° UTM Projection System based on the ETRS89 spatial reference.

Changes of cartographic projections in Germany	
– ca. 1920 - 1939 from Prussian Polyeder Projection to Gauss-Krüger-Projection (Bessel)	
– 1990 to ca. 1995 from Gauss-Krüger (Krassowski) to Gauss-Krüger (Bessel) in the Eastern Federal States	
– 1997 to 2002 from Gauss-Krüger (Bessel) to UTM (WGS84)	

Changes of cartographic projection systems in Germany during the last 100 years

This change concerns 4 out of 7 existing official topographic map series from 1:25,000 to 1:200,000 of the so called pyramid of the official German topographic map series. It is realised within the normal updating programme of 5 years for all topographic maps. This explains the time schedule between 1997 to 2002.

If we admit the idea of a unique cartographic projection system, we have to answer the question of the costs in the member states concerned. The costs mainly depend on the technical means which are available. If we consider that maps are stored in highly developed data bases (referring to both object oriented digital landscape models and to raster data) we only need a specific programme to process the data and to overlie a new coordinate grid. This is the way we are still operating our ongoing programme for changing to UTM (WGS84).

Costs

If our objective is to reach the first level of harmonising the cartographic projection system, we can assume that at least for military map series this level is already reached in all NATO member states and could be reached at rather low costs in the other CERCO member states by modern data processing.

The second level would be to harmonise the map sheet lines. This step would certainly affect the cartographic activities more deeply because a variety of data is referred to the sheet designations such as map number and map name. If we accept the idea of harmonising the sheet lines as well, we have to choose a common system and we have to consider the means of realisation. Under the present circumstances this can only be a long term objective.

A solution to a common sheet line system was proposed by R. Schmidt (Schmidt 1994) which matches all map series from 1:10,000 up to 1:1 Mio and which consists of covering always the next smaller map scale with 4 sheets of the previous map scale (with the exception of the map scale 1:1 Mio).

As this common system can be considered as being more in the interest of the map pro-

Proposition for a harmonised sheet line system:			
1:10,000	3,75'	x	2,5'
1:25,000	7,5'	x	5'
1:50,000	15'	x	10'
1:100,000	30'	x	20'
1:200,000	1°	x	40'
1:1 Mio	6°	x	4°

ducer than in the interest of the map consumer, it would be perfectly consistent to leave it to the appreciation of neighbouring countries whether they want to adopt this system or whether they prefer to preserve their traditional sheet line system.

German contribution to a unique cartographic projection system

Germany is willing to strongly support the idea of a unique cartographic projection in the CERCO and MEGRIN member countries. It has showed its commitment by adopting the Spatial Reference System ETRS89 and by changing to the 60 UTM projecting for the existing official topographic map series. Germany is also prepared to consider a change from Gauss-Krüger to UTM for all object oriented vector data of its ATKIS DLM (Digital Landscape Model). The SMA in Germany are also prepared to consider a change in the current sheet line system if mutual agreements with the neighbouring countries can be concluded.

Conclusions

If the objective of this workshop is to define a middle and long term cooperation and a harmonisation within the EU and CERCO member and observer countries concerning a unique cartographic projection system we should not be satisfied to preserve a situation which originated some hundred years ago, but which does not meet neither the challenges of a unifying Europe nor the opportunities of modern technology. Whether a common projection system can be proposed does not depend on the costs or on any other possible technical problem but mainly on the political will of overcoming traditional borders and working more closely together in the interest of the public as well as in our own interest.

References

- [1] *Grothenn, Dieter* (1994): Einheitliche Gestaltung der amtlichen topographischen Kartenwerke in Europa? In: Kartographische Nachrichten, Heft 1/1994.
- [2] *Schmidt, Rudolf* (1994): Vereinheitlichung des Blattschnitts der topographischen Kartenwerke und ihrer geodätischen Grundlagen in einem europäischen Referenzsystem. In: Nachrichten aus dem öffentlichen Vermessungsdienst NRW, Heft 2/1994.

Projections in small scale atlases - *Christoph Brandenberger*

Geographical graticules are needed for positioning points in maps. A great variety of methods exist to transform these from the sphere, or the ellipsoid, onto the plane. The goal is always to find a projection, that has an overall minimal maximal deformation error. Sometimes special projection properties like conformity or equivalence are stipulated. Therefore, customized projections are required that best conform to the area of interest. Some constraints should be taken into account for choosing an optimal projection.

Introduction

It is essential to investigate some theoretical considerations for specifying an optimal map projection, that best suits the geographical region of interest. Bugayevskiy [1] distinguishes three parameter groups:

Important parameters for choosing an optimal map projection

1. parameters characterizing the region to be mapped
2. parameters characterizing the map, method and conditions of its use
3. parameters characterizing the map projection

Parameters characterizing the region

In this group, the regions are classified in regard to their position on the sphere, dimension, shape, outline and neighboured regions

- geographical position of the region. Three different locations are distinguished:
 - near the pole (polar position)
 - in the middle latitude
 - near the equator (equatorial aspect)
- dimension of the region (part that should be mapped, whole world, continent, country, small region)
 - adjacent regions to be represented
 - shape of region's outlines e.g. Kavraisky characterizes the regions with four different constants.

Parameters characterizing the map, the methods and conditions of its use

- map scale (small, medium, large scaled maps)
 - for maps with a scale greater than 1:3,000,000 in view of the precision the ellipsoidal map projection formulae should be absolutely used for computations
 - for maps with a scale smaller than 1:3,000,000 the use of the spherical map projection formulae is sufficient
- map content (Theme to be represented)
- purpose of the map (for cartometric measurements, for navigational use, etc.)
- accuracy
- nature of display (table, wall or atlas map)
- method of the map generation (manually, computer based)

Figure17:
geographical position.

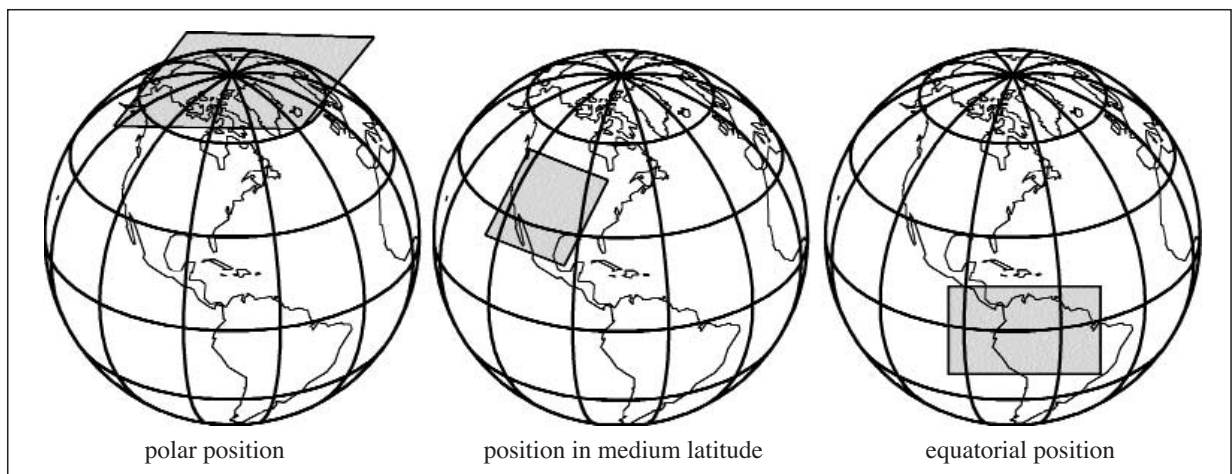

- working conditions (separately used, in combination with other maps, mosaicked, etc.)
- coverage requirement
- relations that should be visible between represented regions.

Parameters characterizing the map projection

- the form and size of the map distortion, illustrated locally by Tissot's indicatrices or isocols (lines of equal deformation)
- required projection properties like: equivalence, equidistance, conformity
- requirement for minimizing the distortion (what is the acceptable maximal values of deformation?)
- pattern of distortion distribution (overall form of the isocols, that bound the outline of the map. e.g. in Snyder's map projection for the 50 states of U.S., which have a quasi rectangular form)
- curvature of the graticule lines (straight, curved)
- outline of the map esp. for world maps, needed layout, map size: A4, A3 etc.

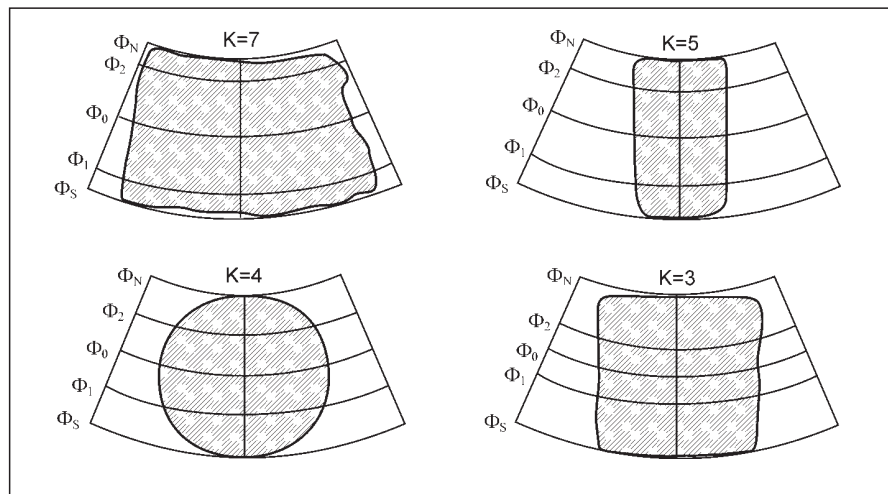

Figure 18:
The characterization of region's outlines according to Kavraisky [source: "Coordinate Systems and Map projections" (D.H. Maling) p. 243].

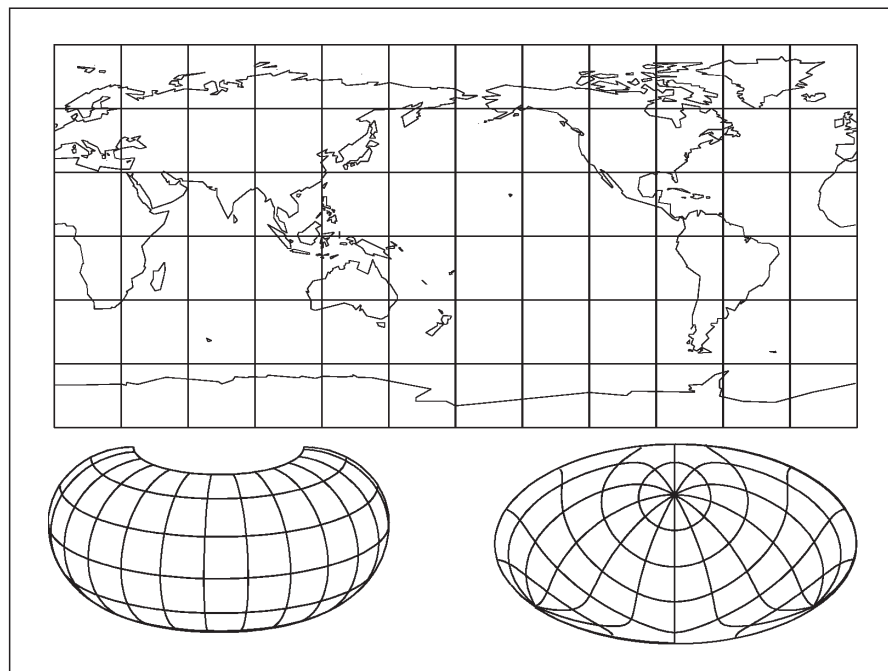

Figure 19:
Curvature of the graticule lines.

Also some additional constraints should be regarded in the process of choosing an optimal map projection, including:

- property of the projection (conformity, equivalence, equidistance, standard parallels)
- requirements of the orthogonality of intersections or limits of deviation from a right angle for meridians and parallels
- spacing of the graticule lines (fine vs. large)
- representation of the poles (as line, as point)
- symmetry of the graticule
- position of the central meridian, also called middle meridian
- localization of the projection origin. It is mostly located in the center of the region of interest
- visual perception (spherical impression, as plane or as a sphere).

According to Bugayevskiy [1], the choice of a suitable map projection is a twofold process (see Figure 21). During step one, a list of all possible projections fulfilling the parameters of group one is established. This means:

- optimal localization of the projection origin and a central meridian, which is orientated in direction of the greatest region extent.

From this follows that the projections should be chosen according to the constraints mentioned below:

- Normal cylindrical projections for regions to be mapped, that are situated near the equator or symmetrical to them
- Conical projections for regions with an east-west extent and with a position at middle latitudes between the equator and the pole
- Normal (polar) azimuthal projections for polar regions
- Transverse or oblique cylindrical projections for mapping regions with an extent along a meridian or vertical
- Transverse or oblique azimuthal projections for nearly circular regions.

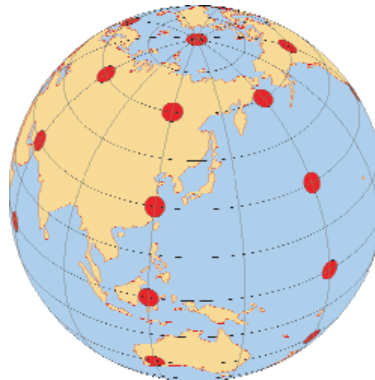

Figure 20: Orthographic projection in an oblique aspect with Tissot's indicatrices.

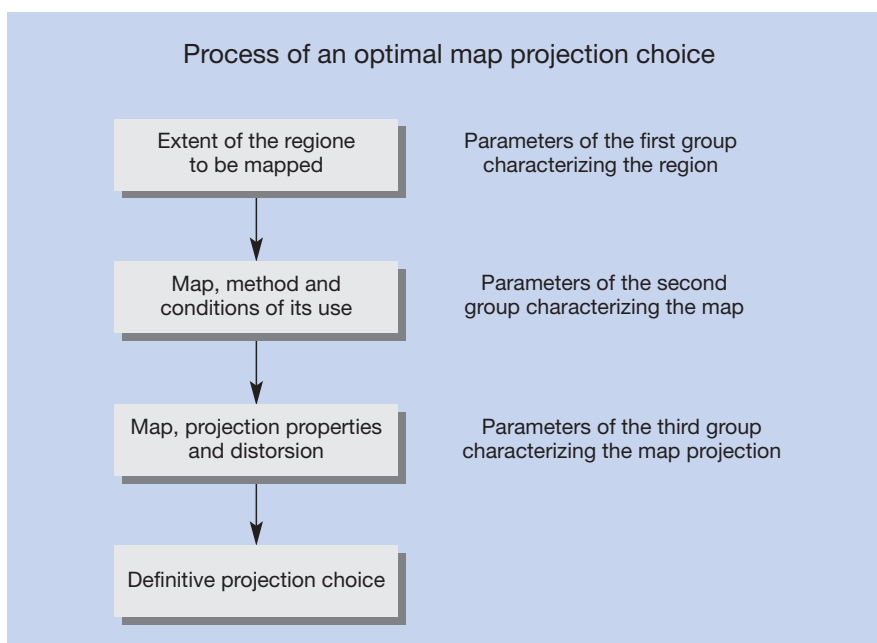

Figure 21: Workflow of a projection choice after Bugayevskiy.

Projections in the Swiss School Atlas (SWA)

Suitable map projections for CORINE project

The above mentioned statements narrow the number of possible projections. This list of eligible projections must be modified in accordance with the parameters of the second group. These parameters are strongly correlated with those of group three. Further parameters that should be fulfilled must be arranged in a priority order. In step two the desired projection is selected according to the list established during step one.

It should be kept in mind that by all transformation from the sphere onto the plane deformations must be taken into account. There are no projections without any deformation errors. But some projection properties could be retained.

Because this atlas is also a textbook for students, it contains a large variety of different map projections. On the last atlas page a short explanation about all used map projections is included (see Figure 22). It is considered, that some basic projection knowledge is important to know regarding the important role of Geographical Information System (GIS) in today's academic curriculum. For instance, a unique projection is utilized for all European country maps. This was evaluated according to the rules for obtaining an optimal projection choice. It is an equal area azimuthal projection in an oblique aspect, with an origin at 46° N and 10° E.

The projection was optimized for the whole of Europe and has minimal maximal angular and scale deformations. The gridlines are computed in one piece. The single country maps are sections of this graticule. Nevertheless, the meridians and parallels of the single map sheet intersect nearly orthogonal. The angular deflection from the right angle can hardly be perceived. All polar regions are mapped in a normal azimuthal projection.

In the literature two treatises about the choice of an optimal map projection for the CORINE project can be found. One undertaken by D.H. Maling (2) and the other by F. Canters (3).

Maling recommended an equal-area azimuthal projection in an oblique aspect for EU-mapping. He found the optimal origin at 48° N and 9° E, which leads to the most minimal deformation error for the whole EU in the old formation. The point of tangency (origin) of the plane to the sphere was determined by visual and computational comparisons of the amount of angular and scale deformation. These projection values were used for the CORINE project and are still in use (see Figure 23).

Canters proposes a slightly modified optimized low-error azimuthal projection for mapping the EU region. The lines of isodeformation (isocols) in Canters' projection design adopt the EU region-outlines. Canters uses a polynomial row with unknown coefficients as a starting point. These coefficients are determined by a comparison of a large amount of distances on the sphere (great circle arc) with their corresponding points projected on the plane. A simplex method according to Nelder and Mead is used for the determination of the coefficients, that leads to an overall minimal distance error. By this way, Canters evaluated a projection that has a lower deformation as well as a better matching of the isocols to the EU outline in comparison to Maling's solution. In the Figure 24, both solutions are shown. The lower deformations and a better fit to the region can be well recognized in the right picture.

Projection algorithm according to Canters
Polynomial row in the form:

$$X = Rf_1(\lambda, \varphi)$$

$$Y = Rf_2(\lambda, \varphi)$$

with

$$f_1(\lambda, \varphi) = \sum_{i=0}^n \sum_{j=0}^{n-1} c_{ij} \lambda^i \varphi^j$$

$$f_2(\lambda, \varphi) = \sum_{i=0}^n \sum_{j=0}^{n-1} c_{ij}^{\circ} \lambda^i \varphi^j$$

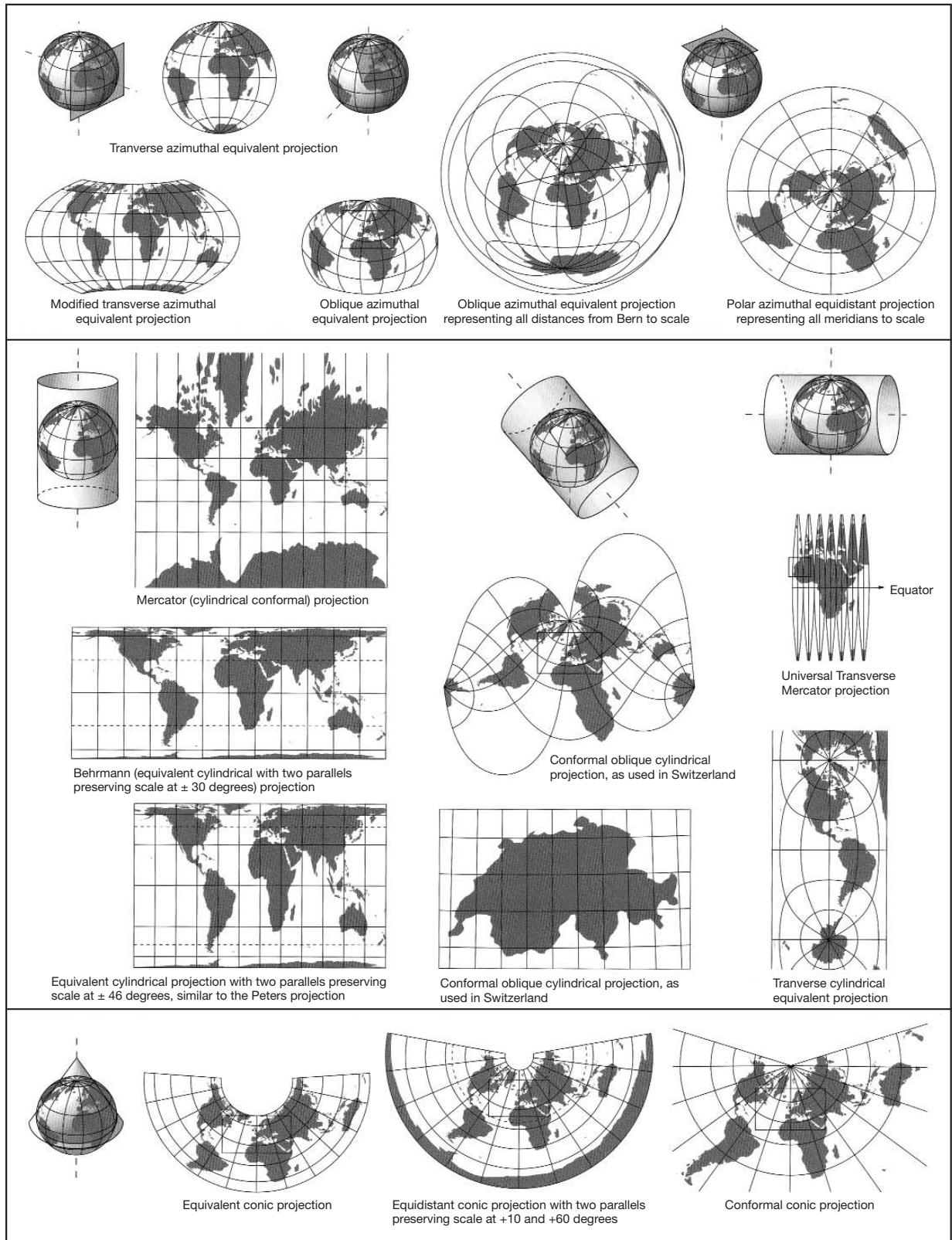

Figure 22: Page with the projection explanations taken from the Swiss World Atlas (courtesy: Konferenz der kantonalen Erziehungsdirektoren (EDK) Schweiz).

Figure 23:
Maling's deformation
comparison of an oblique
equal area conical projection
with an oblique equal area
azimuthal projection (from
Maling p. 261).

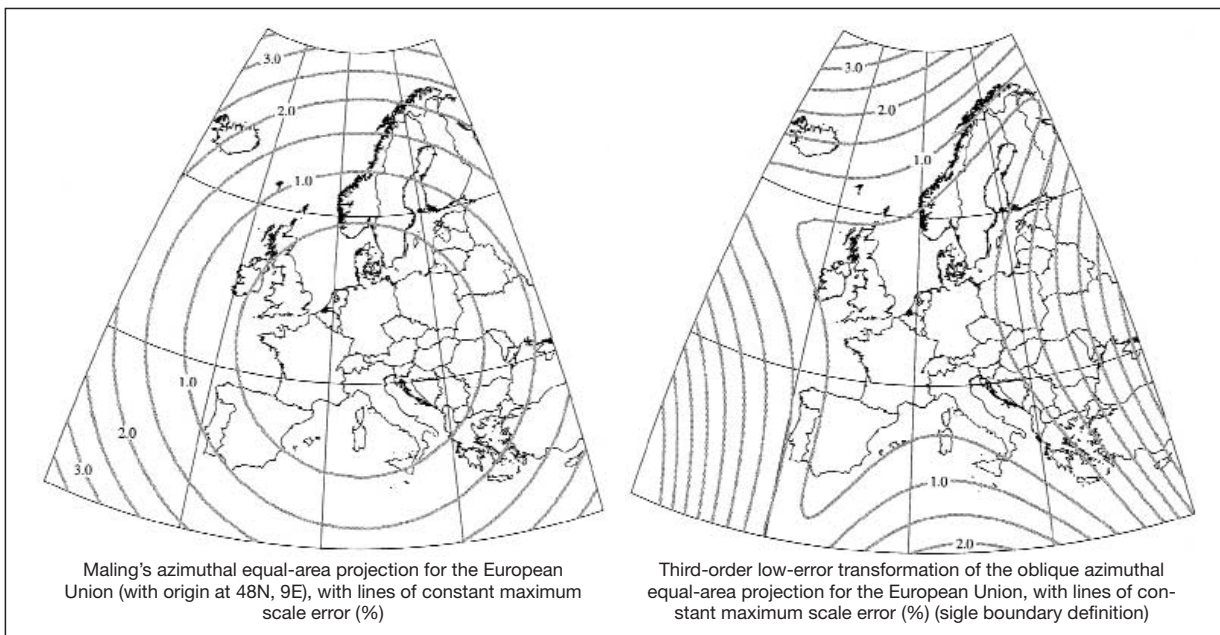
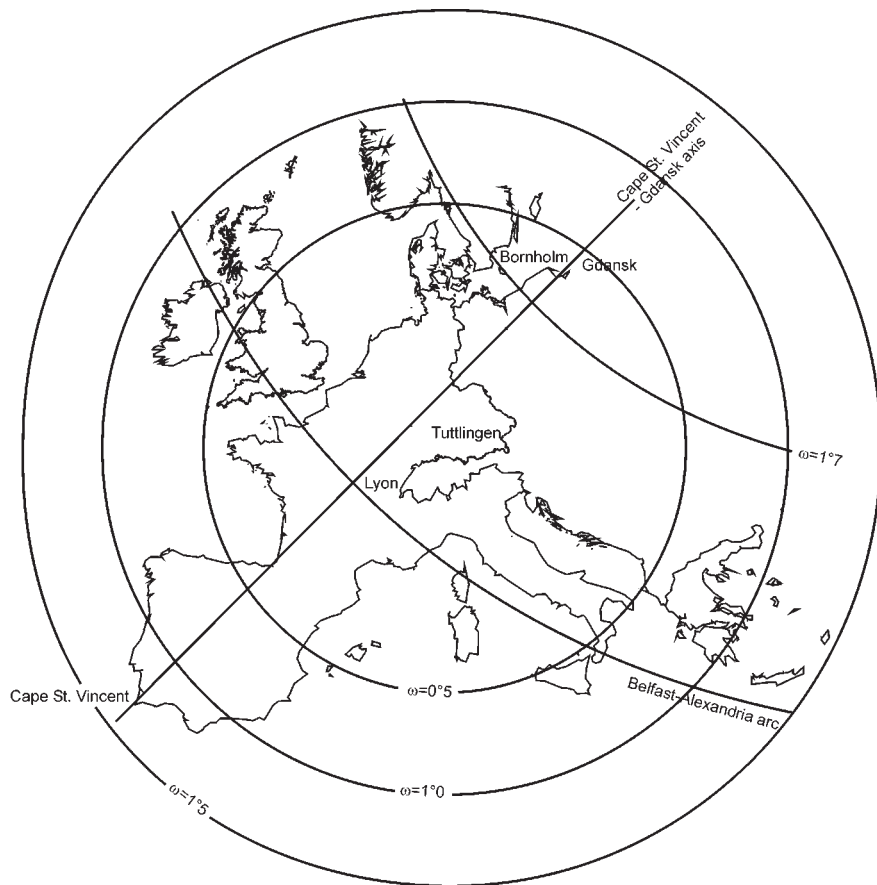

Figure 24:
Comparison of Maling's
recommended projection
with those from Canters
(courtesy Canters).

and the unknown coefficients

c_{ij} resp. c'_{ij}

For a low-error projection a determination of the coefficients by the simplex method according to Nelder and Mead is needed.

function d to minimize

$$d = \left| \frac{s - s'}{s + s'} \right| \quad s' = \sqrt{(x_2 - x_1)^2 + (y_2 - y_1)^2}$$

s' = distance on the map respectively

s = distance on the sphere (nautical triangle)

whereby the distances are irregularly distributed over the whole region of interest.

In the following some advantages and disadvantages of Canters' method are listed.

Advantages

- a projection with a low error deformation
- the lines of equal deformation follow the region outlines
- the projection algorithm is easy to program.

Disadvantages

- this type of projection is not yet implemented in most ordinary commercial software packages
- the inverse projection formulae are currently lacking
- new coefficients will be needed by an extension of the EU-region. Therefore the consistency is not guaranteed between the old and new CORINE maps. It is also essential to know the appropriate transformation algorithm between both CORINE projections. Further on a sophisticated projection labeling of the single map sheets should be elaborated.

Currently it is difficult to find the current parameters of the CORINE projection on the Web or anywhere else. These are strictly necessary for integrating further linear data in existing CORINE raster data sets. Further on it is essential to know information about the mapping precision of CORINE data and the grade of its generalization. Where can you get all this lacking information?

For the determination of an optimal projection with low deformation for EU purposes some conditions must be absolutely known.

- Which requirements stipulate the potential map users?
- Is it possible to map everything in one map projection or should several projections be offered?
- In which way the generalization problem can be handled?
- Is a center of competence for map projection computation and transformation of digital data (raster and vectors) between various map projections necessary? Is a distributed or a centralized solution of value?

For a couple of months, the Institute of Cartography at the Swiss Federal Institute of Technology in Zurich, Switzerland disposes of a web based on-line projection tool. The user is able to specify at home on his PC, by means of a form, the desired projection including the necessary parameters. Among others are these: the extent of the geographical region to be mapped, the density of the grid lines (meridians, parallels), the scale as well as a file with situation data, which must be transformed into projected plane coordinates. These specifications are transferred via http to the server of the institute, where the computation is executed. After termination, the user receives a message and

Canters' method for projection valuation with low error deformation and a good fitting to the region outlines

Questions

Demonstration of an on-line map projection tool

Figure 25:
 Typical workflow of the on-line possibility for computing graticules and transforming data into the appropriated projection provided by the Institute of Cartography at ETHZ.

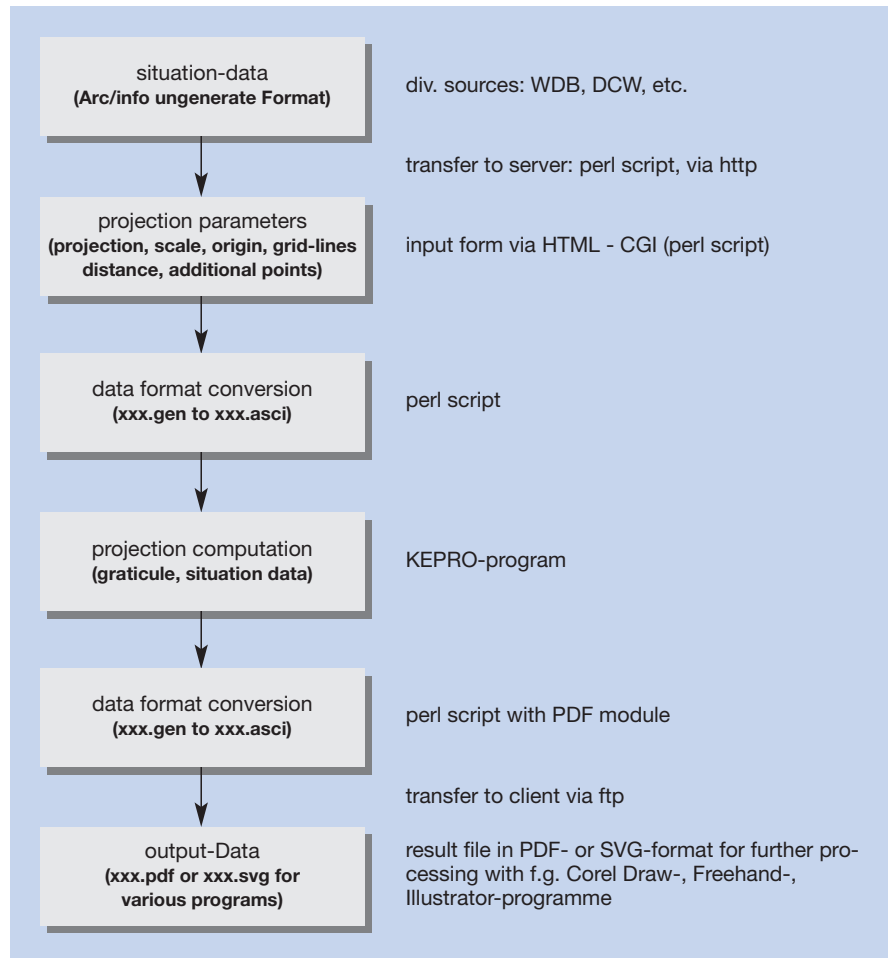

can fetch the data file from the server to his own PC using ftp. The next figure shows the workflow of this web-based map projection computation tool.

In this way, users can easily generate their own geographical graticule and transform data in the appropriate projection. Any special knowledge in the fields of map projection, data transformation as well as the ellipsoid parameters and different data origins is not necessary. It might be that the EU community could establish such a service. This would permit everyone to generate appropriate geographical grids and to transform their own data into desired map projections. This on-line map projection tool, developed by the Institute of Cartography at ETHZ, shows that such a solution is possible. Some adaptations to EU needs may be necessary. Furthermore, specialists can establish and sustain such a modern computation tool every time and modify it if necessary. The available input data format is ARC/INFO ungenerate. As output, the PDF- or SVG-format stands at disposition. These two are very common and are now implemented as a standard input filter in many commercial graphic systems.

References

- [1] L.M. Bugayevskiy, J.P.Snyder (1995). Map Projections A Reference Manual, Taylor and Francis Ltd. London.
- [2] D.H. Maling (1992). Coordinate Systems and Map Projections, Pergamon Press Oxford.
- [3] F. Canters (1999). Semi-automated map projection design, Ph.D. thesis (unpublished) Vrije Universiteit Brussel.

List of workshop participants

Gabriela Augusto

European Topic Centre on Nature Conservation
(ETC/NC)

Muséum National d'Histoire Naturelle
57, rue Cuvier, 75231 Paris Cedex 05, France
Tel. 33 (0)1 40 79 38 78
Fax 33 (0)1 40 79 38 67
E-mail: augusto@mnhn.fr

Heinz Bennat

Bundesamt für Kartographie und Geodäsie
Richard-Strauss-Allee 11, D-60598 Frankfurt,
Germany
Tel. 49 (0) 69 6333 304
Fax 49 (0) 69 6333 441
<http://www.ifag.de/>
E-mail: bennat@ifag.de

Christoph Brandenberger

Institut für Kartographie,
ETH Honggerberg
CH 8093 Zurich
Switzerland
Tel. +41 1 633 3032
Fax +41 1 633 1153
<http://www.karto.ethz.ch>
E-mail: brandenberger@karto.baug.ethz.ch

Francis Dhee

Cellule Pédagogique et de Recherche en Cartographie
Ecole Nationale des Sciences Géographiques
6 et 8, Avenue Blaise Pascal, Cité Descartes,
Champs sur Marne
77455 Marne la Vallée Cedex 2, France
Tel. 33(0) 1 64153185
Fax 33 (0) 1 64153107
E-mail: dhee@ensg.ign.fr

Lars Engberg

NLS Sweden, Geodetic Research Department
National Land Survey of Sweden, Lantmäteriet
SE-801 82 Gävle, Sweden
Tel. 46 26 63 30 37
Fax 46 26 61 06 76
<http://www.lantmateriet.se>
E-mail: lars.e.engberg@lm.se

Iain Greenway

Ordnance Survey Ireland
Phoenix Park, Dublin 8, Ireland
Tel. 353 1 802 5316
Fax 353 1 820 4156
<http://www.osi.ie>
E-mail: iain.greenway@osi.ie

Johannes Ihde

Bundesamt für Kartographie und Geodäsie
Abteilung Geodäsie
Außenstelle Leipzig, Karl-Rothe-Straße 10-14
D-04105 Leipzig, Germany

Tel. 49 341 5634 424
Fax 49 341 5634 415
E-mail: ihde@leipzig.ifag.de

Roger Lott

BP Exploration, 200 Chertsey Road,
Sunbury on Thames, Middlesex TW16 7LN,
United Kingdom
Tel. 44 (0)1932 764365
Fax 44 (0)1932 764460
E-mail: lottrj@eu1.bp.com

Jean-Philippe Lagrange

IGN
Tel. +33 1 43 98 82 70
Fax +33 1 43 98 84 00
E-mail: Jean-Philippe.Lagrange@ign.fr

Peter G.M. Mekenkamp

Utrecht University, Faculty of Geographical Sciences
Section Cartography, P.O. Box 80.115, 3508 TC
Utrecht
Tel. 31 30 253 2047
Tel. 00 31 30 253 1385
E-mail: p.mekenkamp@geog.uu.nl

Manfred Oster

Geotopographie und Kartographie
Landesvermessungsamt Nordrhein-Westfalen
Muffendorfer Straße 19-21, 53177 Bonn (Bad
Godesberg), Germany
Tel. (0228) 846 3400
Fax (0228) 846 3002
E-mail: oster@lverma.nrw.de

Marc Roekaerts

European Topic Centre on Nature Conservation
(EEA-ETC/NC)
EUREKO@pophost.eunet.be

Lysandros Tsoulos

Faculty of Rural and Surveying Engineering
National Technical University of Athens
9.H.Polytechniou Str., 157 80 Zographou Campus,
Athens, Greece
Tel. 30 1 772 2730
Fax 30 1 772 2670
E-mail: lysandro@central.ntua.gr

Stefan A.Voser

Switzerland
<http://www.mapref.org>

Marcus Wandinger

Der Persönliche Referent des Präsidenten
Bayerisches Landesvermessungsamt
Alexandrastraße 4, 80538 München, Germany
Tel. 49 (0)89 2129 1276
Fax 49 (0)89 2129 21276
<http://www.geodaten.bayern.de>
E-mail: Marcus.Wandinger@blva.bayern.de

EUROGEOGRAPHICS

C. Luzet

EuroGeographics
6 et 8, Avenue Blaise Pascal, Cité Descartes,
Champs-sur-Marne
77455 Marne la Vallée Cedex 2, France
Tel. 33(0) 1 64153240
Fax 33 (0) 1 64153219
<http://www.EuroGeographics.org>
E-mail: claudeluzet@EuroGeographics.org

Tim Hancock

EuroGeographics
6 et 8, Avenue Blaise Pascal, Cité Descartes,
Champs-sur-Marne
77455 Marne la Vallée Cedex 2, France
Tel. +33 (0) 1 64 15 32 78
Fax +33 (0) 1 64 15 32 19
<http://www.EuroGeographics.org>
E-mail: tim.hancock@megrin.org

EUROPEAN COMMISSION

Alessandro Annoni

Joint Research Centre
Institute for Environment and Sustainability
Tel. +39 0332 786166
Fax +39 0332 789803
21020 Ispra (VA) - Italy
<http://www.ec-gis.org/>
E-mail: alessandro.annoni@jrc.it

Albrecht Wirthmann

Eurostat
Unit E4, GISCO
Jean Monnet Building-L-2920 Luxembourg
Tel. 352 4301 33728

Fax 352 4301 34029

<http://europa.eu.int/comm/eurostat/>
E-mail: albrecht.wirthmann@cec.eu.int

Jacques Delincé

Eurostat
Unit F2,
Batiment Jean Monnet, Rue Alcide de Gasperi
L-2920 Luxembourg
Tel. 352 430 132140
Fax 352 430 137318
E-mail: jacques.delince@cec.eu.int

Jean Francois Dallemand

Joint Research Centre
Institute for Environment and Sustainability
TP 262 I-21020 Ispra (Va) Italy
Tel. +39 0332 789937
Fax +39 0332 789074
<http://www.ec-gis.org/>
E-mail: jf.dallemand@jrc.it

Vanda Perdigão

Joint Research Centre
Institute for Environment and Sustainability
TP 262 I-21020 Ispra (Va) Italy
Tel. +39 0332 785052
Fax +39 0332 789029
E-mail: vanda.perdigao@jrc.it

Chris Steenmans

European Environment Agency,
Kongens Nyrtov 6, DK-1051, Copenhagen,
Denmark
Tel. +45 33367116
Fax +45 33367199
<http://www.eea.eu.int/>
E-mail: chris.steenmans@eea.eu.int

The Vertical Reference System for Europe - *J. Ihde, W. Augath*

Responding to an urgent request of the Comité Européen des Responsables de la Cartographie Officielle (CERCO) for an European Height System a 0.1 m accuracy level the Technical Working Group of the IAG Subcommission on Continental networks for Europe (EUREF) proposed in 1994 a new adjustment and an enlargement of the United European Levelling Network to Eastern Europe (Resolution 3 of the EUREF Symposium in Warsaw, 1994). The decision for the realization of the European Vertical Reference System (EUVN) in 1995 was a big step toward a modern integrated reference system for Europe which combines GPS coordinates, gravity related heights and sea level heights in one data set. It was decided for Europe to derive the gravity related heights as normal heights from geopotential numbers (Resolution 2 of the EUREF Symposium in Ankara, 1996). In 1999 the European Spatial Reference Workshop recommended the European Commission (EC) to adopt a vertical reference system on the basis of the results of the UELN and EUVN projects for the specifications of the products to be delivered to the EC. Furthermore it promoted the wider use within all member states in future.

Introduction

A height reference system is characterized by the vertical datum and the kind of gravity related heights. The vertical datum is in most cases related to the mean sea level, which is estimated at one or more tide gauge stations. The tide gauge stations of the national height systems in Europe are located at various oceans and inland seas: Baltic Sea, North Sea, Mediterranean Sea, Black Sea, Atlantic Ocean. The differences between these sea levels can amount to several decimeters. They are caused by the various separations between the sea surface and the geoid.

Present status

In addition the used height datums often are of historical nature, as well as not all zero levels are referred to the mean sea level. There are also zero levels referred to the low tide (Ostend) or to the high tide. For example the Amsterdam zero point is defined by mean high tide in 1684.

In Europe three different kinds of heights are being used: normal heights, orthometric heights and normal-orthometric heights. Examples for the use of orthometric heights are Belgium, Denmark, Finland, Italy and Switzerland. Today normal heights are being used in France, Germany, Sweden and in the most countries of Eastern Europe.

After a break of ten years, the work on the UELN was resumed in 1994 under the name UELN-95. The objectives of the UELN-95 project were to establish a unified height system for Europe at the one decimeter level with the simultaneous enlargement of UELN as far as possible to include Central and Eastern European countries and the development of a kinematic height network "UELN 2000" step by step. Starting point for the UELN-95 project has been a repetition of the adjustment of the UELN-73/86. In contrast to the weight determination of the 1986 adjustment for UELN-95 the weights were derived from a variance component estimation of the observation material which was delivered by the participating countries and introduced into the adjustment.

United European Levelling Network (UELN)

The adjustment is performed in geopotential numbers as nodal point adjustment with variance component estimation for the participating countries and as a free adjustment linked to the reference point of UELN-73 (Amsterdam).

The development of the UELN-95 is characterized by two different kinds of enlargements: the substitution of data material of such network blocks (which had been already part of UELN-73) by new measurements with improved network configuration, and on the other hand by adding new national network blocks of Central and Eastern Europe which were not part of UELN-73.

In the year 1998 more than 3000 nodal points were adjusted and linked to the Normaal Amsterdams Peil (the reference point of the UELN-73). The normal heights in the system UELN-95/98 are available for more than 20 participating countries.

European Vertical Reference Network (EUVN)

The initial practical objective of the EUVN project was to unify different national height datums in Europe within few centimeters also in those countries which were not covered by the UELN. Additionally this project was thought as preparation of a geokinematic height reference system for Europe and a way to connect levelling heights with GPS heights for the European geoid determination.

At all EUVN points three-dimensional coordinates in the ETRS89 and geopotential numbers will be derived. Finally the EUVN is representing a geometrical-physical reference frame. In addition to the geopotential numbers the corresponding normal heights will be provided. In the tide gauge stations the connection to the sea level will be realized.

In total the EUVN consists of about 196 sites: 66 EUREF and 13 national permanent sites, 54 UELN and UPLN (United Precise Levelling Network of Central and Eastern Europe) stations and 63 tide gauges.

The final GPS solution was constrained to ITRF96 coordinates (epoch 1997.4) of 37 stations. For many practical purposes it is useful to have the ETRS89 coordinates available. To reach conformity with other projects, the general relations between ITRS and ETRS were used.

In the year 2000 the connection levellings and computations of normal heights in UELN-95/98 were finished.

European Vertical Reference System (EVRS)

The Spatial Reference Workshop in Marne-la-Vallée in November 1999 recommended the European Commission European reference systems for referencing of geo data. For the height component the workshop recommended that the European Commission:

- adopts the results of the EUVN/UELN initiatives when available, as definitions of vertical datum and gravity-related heights;
- includes the EUVN reference system so defined for the specifications of the products to be delivered to the EC, within projects, contracts, etc;
- future promotes the wider use of the European vertical reference system within all member states, by appropriate means (recommendations, official statement, ...).

The Technical Working Group of the IAG Subcommission for Europe (EUREF) was asked to define a European Vertical Reference System and to describe its realization. After a discussion at the plenary of the symposium it was decided to specify the definition. Two contributions in this discussion about the treatment of the permanent tidal effect (MÄKINEN, EKMAN) are added to this publication.

The principles of the realization of the EVRS were adopted at the EUREF Symposium 2000 in Tromsø by the resolution no. 5:

The IAG Subcommission for Europe (EUREF) noting the recommendation of the spatial referencing workshop, in Marne-la-Vallée 27-30 November 1999, to the European Commission to adopt the results of the EUVN/UELN projects for Europe wide vertical referencing, decides to define an European Vertical Reference System (EVRS) characterized by:

- *the datum of 'Normaal Amsterdams Peil' (NAP)*
- *gravity potential differences with respect to NAP or equivalent normal heights,*

endorses UELN95/98 and EUVN as realizations of EVRS using the name EVRF2000, asks the EUREF Technical Working Group to finalize the defini-

tion and initial realization of the EVRS and to make available a document describing the system.

For referencing of geo information in a unique system transformation parameters between the national heights systems and the EVRS frame are also available, see Sacher et al. (1999a).

References

- [1] Augath, W. (1994): Proposals for a European Task force on Vertical Datums within the EUREF-Subcommission. Presented at the EUREF-Symposium in Warsaw, June 8-11, 1994. In: Veröffentlichungen der Bayerischen Kommission für die Internationale Erdmessung. München, Heft Nr. 54, S. 171-175.
- [2] Augath, W. (1996): UELN-2000 - Possibilities, Strategy, Concepts - or: How should we realize a European Vertical System? Presented at the EUREF Symposium in Ankara, May 22-25, 1996. In: Veröffentlichungen der Bayerischen Kommission für die Internationale Erdmessung. München, 1996, Heft Nr. 57, S. 170-174.
- [3] Ekman, M.: On the permanent tide in the European Vertical Reference System. In: Veröffentlichung der Bayerischen Kommission für die Internationale Erdmessung. München, 2001, Heft Nr. 61, S.
- [4] Ihde, J., Adam, J., Gurtner, W., Harsson, B.G., Schlüter, W., Wöppelmann, G. (1999a): The Concept of the European Vertical GPS Reference Network (EUVN). Presented at the EUREF Symposium in Bad Neuenahr-Ahrweiler, June 10-13, 1998. In: Mitteilungen des Bundesamtes für Kartographie und Geodäsie, EUREF Publication No. 7/II, Frankfurt am Main, 1999, Bd. 7, S. 11 22.
- [5] Ihde, J., Boucher, C., Dunkley, P., Farrell, B., Gubler, E., Lutherdt, J., Torres, J.: European Spatial Reference Systems – Frames for Geoinformation System . Presented at the EUREF Symposium in Tromsø, June 22-24, 2000. In: Veröffentlichung der Bayerischen Kommission für die Internationale Erdmessung. München, 2001, Heft Nr. 61, S.
- [6] Mäkinen, J.: A note on the treatment of the permanent tidal effect in the European Vertical Reference System (EVRS). In: Veröffentlichungen der Bayerischen Kommission für die Internationale Erdmessung. München, 2001, Heft Nr. 61, S.
- [7] Rummel, R., Heck, B.: Some Critical Remarks on the Definition and Realization of the EVRS. In: Veröffentlichung der Bayerischen Kommission für die Internationale Erdmessung. München, 2001, Heft Nr. 61, S.
- [8] Sacher, M., Ihde, J., Seeger, H. (1999a). Preliminary transformation relations between national European height systems and the United European Levelling Network (UELN). Prepared for the CERCO Plenary, Oslo, September 1998. Presented at the EUREF Symposium, Prague, June 2-4, 1999. In: Veröffentlichungen der Bayerischen Kommission für die Internationale Erdmessung. München, 1999, Heft Nr. 60, S. 80 - 86.
- [9] Sacher, M., Ihde, J., Celms, A., Ellmann, A. (1999b): The first UELN stage is achieved, further steps are planned. Presented at the EUREF Symposium, Prague, June 2 4, 1999. In: Veröffentlichungen der Bayerischen Kommission für die Internationale Erdmessung. München, 1999, Heft Nr. 60, S. 87 94.
- [10] European Vertical Reference System (EVRS), International Association of Geodesy, Section I - Positioning, Commission X - Global and Regional Networks, Subcommission for Europe (EUREF). Presented at the EUREF Symposium, Tromsø, June, 22-24, 2000. In: Veröffentlichungen der Bayerischen Kommission für die Internationale Erdmessung. München, 2001, Heft Nr. 61, S.

European Vertical Reference System (EVRS)

International Association of Geodesy
 Section I – Positioning
 Commission X – Global and Regional Networks
 Subcommission for Europe (EUREF)

Preamble This document

- defines the European Vertical Reference System (EVRS) including a European Vertical Datum and the European Vertical Reference Frame as its realization and for practical use as a static system under the name EVRF2000;
- is for adoption by the European Commission to promote widespread use as a defacto standard for future pan-European data products and services.

Definition The European Vertical Reference System (EVRS) is a gravity-related height reference system. It is defined by the following conventions:

a) The vertical datum is the zero level for which the Earth gravity field potential W_0 is equal to the normal potential of the mean Earth ellipsoid U_0 :

$$W_0 = U_0$$

b) The height components are the differences ΔW_P between the potential W_P of the Earth gravity field through the considered points P and the potential of the EVRS zero level W_0 . The potential difference $-\Delta W_P$ is also designated as geopotential number c_P :

$$-\Delta W_P = W_0 - W_P = c_P$$

Normal heights are equivalent to geopotential numbers.

c) The EVRS is a zero tidal system, in agreement with the IAG Resolutions²⁰.

The European Vertical Reference Frame 2000 (EVRF2000)

The EVRS is realized by the geopotential numbers and normal heights of nodal points of the United European Levelling Network 95/98 (UELN 95/98) extended for Estonia, Latvia, Lithuania and Romania in relation to the Normaal Amsterdams Peils (NAP). The geopotential numbers and normal heights of the nodal points are available for the participating countries under the name UELN 95/98 to which is now given the name EVRF2000.

Realization of the datum

a) The vertical datum of the EVRS is realized by the zero level through the Normaal Amsterdams Peil (NAP). Following this, the geopotential number in the NAP is zero:

$$c_{NAP} = 0$$

b) For related parameters and constants of the Geodetic Reference System 1980 (GRS80) is used. Following this the Earth gravity field potential through NAP W_{NAP} is set to be the normal potential of the GRS80:

$$W_{NAP}^{REAL} = U_{0GRS80}$$

c) The EVRF2000 datum is fixed by the geopotential number and the equivalent normal height of the reference point of the UELN No. 000A2530/13600.

²⁰ In a) and b) the potential of the Earth includes the potential of the permanent tidal deformation but excludes the permanent tidal potential itself.

Country	UELN number	Position in ETRS89 ellipsoidal latitude ellipsoidal longitude in ° ' "	Height in UELN95/98		Gravity in IGSN71 in m ² · s ⁻²
			geopotential number in m ² · s ⁻²	normal height in m	
Reference point of EVRS 000A2530 The Netherlands	13600	52° 22' 53" 4° 54' 34"	7.0259	0.71599	9.81277935

The Adjustment of UELN-95/98

The adjustment of geopotential numbers was performed as an unconstrained adjustment linked to the reference point of UELN-73 (in NAP). Both the geopotential numbers and the normal heights of UELN 95/98 of the adjustment version UELN-95/13 were handed over in January 1999 to the participating countries as the UELN-95/98 solution.

Parameters of the UELN-95/98 adjustment are the following:

- number of fixed points: 1
- number of unknown nodal points: 3063
- number of measurements: 4263
- degrees of freedom: 1200
- a-posteriori standard deviation referred to a levelling distance of 1 km: 1.10 kgal mm
- mean value of the standard deviation of the adjusted geopotential number differences: 6.62 kgal mm
- mean value of the standard deviation of the adjusted geopotential numbers ($\hat{=}$ heights): 19.64 kgal mm
- average redundancy: 0.281

The normal heights H_n were computed by $H_n = c_p/\gamma$, where γ is the average value of the normal gravity along the normal plumb line between the ellipsoid and the telluroid. The average value of the normal gravity along the normal plumb line is determined by

$$\bar{\gamma} \approx \gamma_m = \gamma_0 - \frac{0.3086 \text{ mgal/m} \cdot h}{2} + \frac{0.072 \cdot 10^{-6} \text{ mgal/m}^2 \cdot h^2}{2}$$

with the Gravity Formula 1980 and latitude in ETRS89.

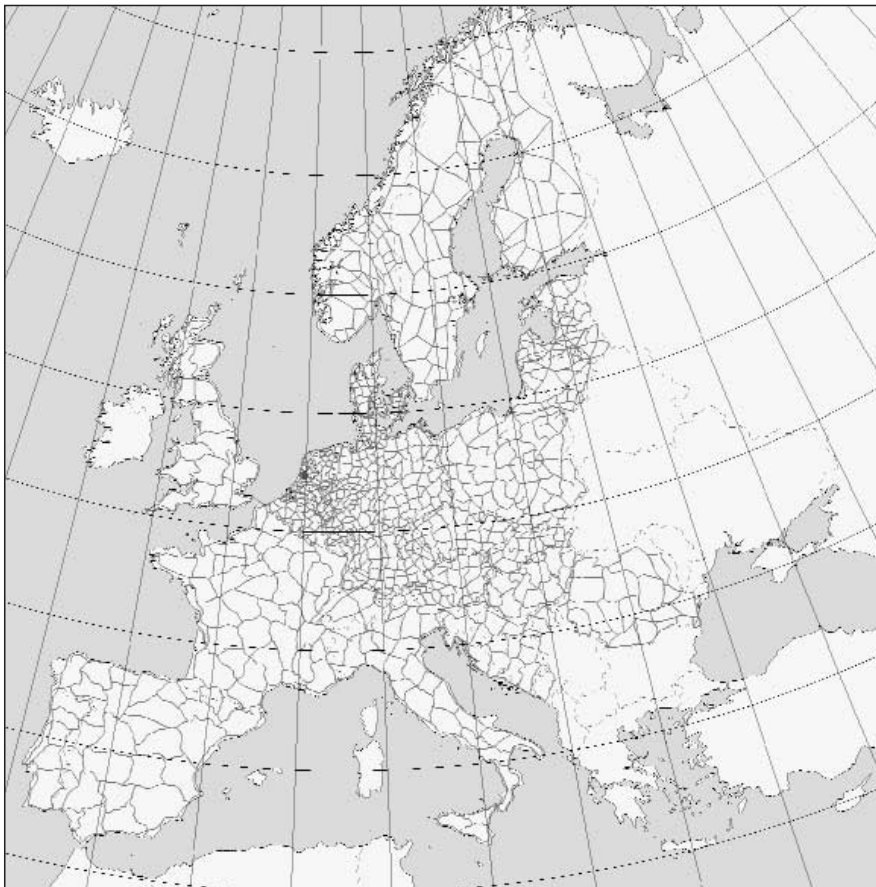
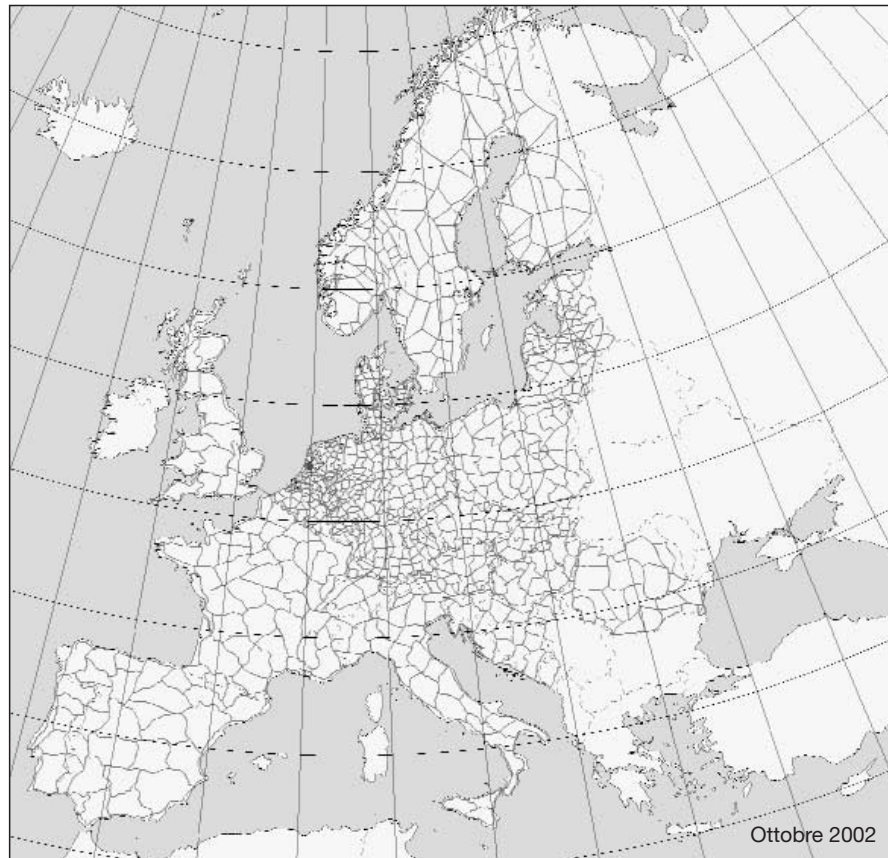

Figure 26:
United European Levelling Network 1995 (UELN-95/98 – extended for Estonia, Latvia, Lithuania and Romania).

Figure 27:
 UELN 95/98 – Isolines of
 Precision [kgal mm].



Addendum Datum relations

Relations between the defined and the realized EVRS datum

The potential of the Earth gravity field in the NAP is processed by

$$W_{NAP} = W_0 + \Delta W_{SST} + \Delta W_{TGO}$$

where

ΔW_{SST} is the sea surface topography potential difference at the tide gauge Amsterdam in relation to a geoid with $W_0 = U_0$

ΔW_{TGO} is the potential deviation between the NAP level W_{NAP} and the level of the mean sea surface at the tide gauge Amsterdam

The relation between the EVRS datum and its realization in EVRF2000 is expressed by

$$\begin{aligned} \Delta W_{EVRS} &= W_{NAP} - W_{NAP}^{REAL} \\ &= W_{NAP} - U_{0\ GRS80} \\ &= U_0 - U_{0\ GRS80} + \Delta W_{SST} + \Delta W_{TGO} \end{aligned}$$

ΔW_{EVRS} is the offset to a world height system. The relation to a world height system with $W_0 = U_0$ needs the knowledge of the sea surface topography and the deviation in the NAP in connection with the normal potential at the mean Earth ellipsoid U_0 (at present $U_0 \sim 62636856\ m^2\ s^{-2}$) at a cm-accuracy level.

Relations between the EVRS2000 datum and datums of National Height Systems in Europe

In Europe three different kinds of heights (normal heights, orthometric heights and normal-orthometric heights) are used: Examples for the use of orthomet-

ric heights are Belgium, Denmark, Finland, Italy and Switzerland. Today normal heights are used in France, Germany, Sweden and in most countries of Eastern Europe. In Norway, Austria and in the countries of the former Yugoslavia normal-orthometric heights are used.

The vertical datum is determined by the mean sea level, which is estimated at one or more tide gauge stations. The reference tide gauge stations to which the zero levels of the national European height systems in Europe are related are located at various oceans and inland seas: Baltic Sea, North Sea, Mediterranean Sea, Black Sea, Atlantic Ocean. The differences between the zero levels can come up to several decimeters. They are caused by the various separations between the ocean surface and the geoid as well as by the definition of the level.

The current situation of national height systems in Europe is characterised by Figure 28 and Figure 29.

Figure 30 shows the distribution of the mean transformation parameters from the national height systems to the EVRF2000.

The following table summarizes the information about the relations between the EVRF2000 zero level and the zero levels of national height systems in Europe.

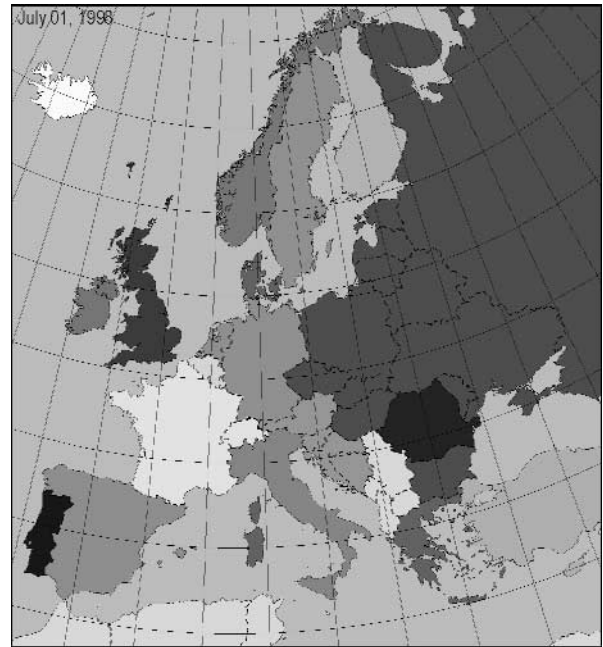

Alicante	Constanta	Malin Head	Tregde
Amsterdam	Genova	Marseille	Trieste
Antalya	Helsinki	Newlyn	no information
Cascais	Kronstadt	Ostende	other

Figure 28:
Reference Tide Gauges of National Height Systems in Europe.

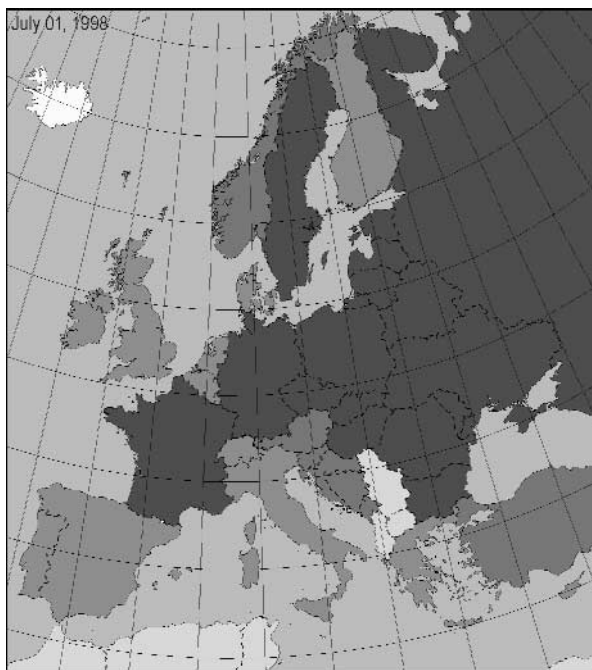

normal heights	no information
orthometric heights	no levelling heights
normal orthometric heights	

Figure 29:
Kind of Heights of National Height Systems in Europe.

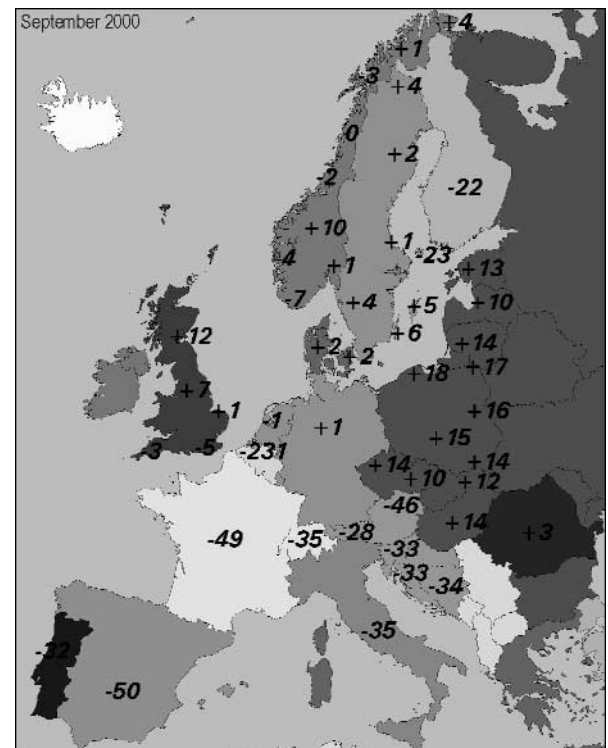

Figure 30:
Differences between EVRF2000 zero level and the zero levels of national height systems in Europe (in cm).

Table 10:
Preliminary Transformation
Parameters from National
European Height Systems
to the EVRF2000

Country (country code)	Reference Tide Gauge	Kind of Heights	UELN-Nat. Height in cm	min/max in cm	No. of Identical Points
Albania	Durres				
Austria	Trieste	NOH	- 35	- 25/- 48	100 (UELN)
Belgium	Ostend	OH	- 231	- 230/- 232	4 (EUVN)
Belorussia	Kronstadt	NO	+ 15		
Bosnia/ Herzegovina	Trieste	NOH	- 34	- 33/- 34	5 (UELN)
Bulgaria	Kronstadt	NH	+ 15		
Croatia	Trieste	NOH	- 33	- 32/- 35	4 (UELN)
Czech Republic	Kronstadt	NH	+ 11	+ 8/+ 16	53 (UELN)
Denmark	10 Danish tide gauges	OH	+ 2	+ 1/+ 3	733 (UELN)
Estonia	Kronstadt	NH	+ 13	+ 12/+ 15	36 (UELN)
Finland	Helsinki	OH	+ 22	+ 22/+ 23	8 (EUVN)
France	Marseille	NH	- 49	- 48/- 49	7 (EUVN)
Germany	Amsterdam	NH	+ 1	+ 1/+ 2	431 (UELN)
Greece					
Hungary	Kronstadt	NH	+ 14	+ 13/+ 14	4 (EUVN)
Iceland	no levelling heights				
Ireland	Malin Head	OH			
Italy	Genoa	OH	- 35	- 33/- 36	11 (EUVN)
Latvia	Kronstadt	NH	+ 10	+ 8/+ 12	124 (UELN)
Lithuania	Kronstadt	NH	+ 14	+ 13/+ 14	46 (UELN)
FYR of Macedonia	Trieste	OH			
Moldavia	Kronstadt	NH	+ 15		
Netherlands	Amsterdam	OH	- 1	0/- 3	758 (UELN)
Norway	Tregde	NOH	0	- 7/+ 10	10 (EUVN)
Poland	Kronstadt	NH	+ 16	+ 14/+ 18	117 (UELN)
Portugal	Cascais	OH	- 32	- 29/- 33	5 (EUVN)
Romania	Constanta	NH	+ 3	+ 2/+ 4	64 (UELN)
Russia	Kronstadt	NH	+ 15		
Slovakia	Kronstadt	NH	+ 12	+ 11/+ 13	3 (EUVN)
Slovenia	Trieste	NOH	- 33	- 33/- 34	9 (UELN)
Spain	Alicante	OH	- 50	- 47/- 52	7 (UELN)
Sweden	Amsterdam	NH	+ 3	0/+ 6	11 (EUVN)
Switzerland	Marseille	OH (NH)	- 35 - 17	- 16/- 56 - 15/- 22	7 (EUVN)
Turkey	Antalya	OH			
Ukraine	Kronstadt	NH	+ 15		
United Kingdom	Newlyn	OH	+ 2	+ 12/- 5	5 (EUVN)
Yugoslavia	Trieste	NOH			

Remark:

NH: normal heights,

NOH: normal-orthometric heights,

OH: orthometric heights

European Spatial Reference System European Vertical Reference Network (EUVN)

The initial practical objective of the EUVN project is to unify different European height datums within few centimeters. The EUVN project contributes to the realization of a European vertical datum and to the connection of different sea levels of European oceans with respect to the work of PSMSL (Permanent Service of Mean Sea Level) and of anticipated accelerated sea level rise due to global warming. The project provides a contribution to the determination of an absolute world height system.

At all EUVN points P three-dimensional coordinates in the ETRS89 (X_p , Y_p , Z_p)_{ETRS} and geopotential numbers $c_p = W_{o\text{ UELN}} - W_p$ will be derived. Finally

the EUVN is representing a geometrical-physical reference frame. In addition to the geopotential numbers c_p normal heights $H_n = c_p/\gamma$ will be provided.

In total the EUVN consists of 196 sites: 66 EUREF and 13 national permanent sites, 54 UELN and UPLN (United Precise Levelling Network of Central and Eastern Europe) stations and 63 tide gauges (Figure 31).

The final GPS solution was constrained to ITRF96 coordinates (epoch 1997.4) of 37 stations with an a-priori standard deviation of 0.01 mm for each coordinate component. As a consequence of these tight constraints the resulting coordinates of the reference points are virtually identical with the ITRF96 values. To get conformity with other projects, the general relations were used to transform the ITRS coordinates to ETRS. The coordinate transform formula from ITRF96 to ETRF96 and the final coordinates are given in Ineichen et al 1999.

In order to reach the goal it is necessary to connect the EUVN stations by levellings to nodal points of the UELN 95/98 network. The geopotential numbers are related to the EVRS2000 zero level. As the EUVN is a static height network it is necessary to know the value of the mean sea level in relation to the tide gauge bench mark at the epoch of EUVN GPS campaign 1997.5.

The Permanent Service for Mean Sea Level (PSMSL) as member of the Federation of the Astronomical and Geophysical Data Analysis Service (FAGS) is in principle in charge of the data collection. The information which is sent to the PSMSL databank is available for the EUVN project.

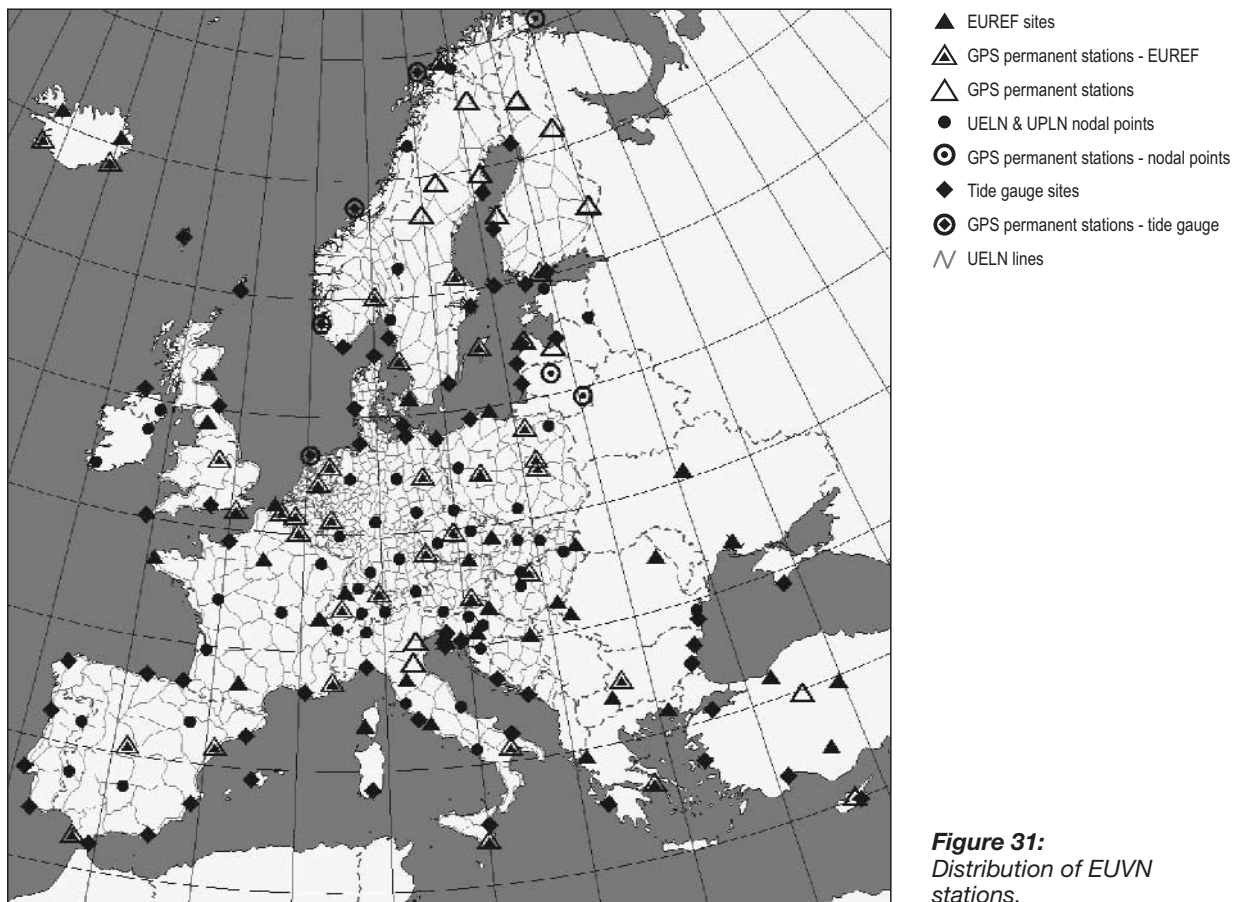

Figure 31:
Distribution of EUVN stations.

A Kinematic European Vertical System (EVS)

The European Vertical System is planned as geokinematic height network as combination of the European GPS permanent station network, the UELN with repeated levellings, the European gravimetric geoid and tide gauge measurements along European coast lines as well as repeated gravity measurements. In May 1999 a special working group was formed to determine the direction of future work. At the first working group meeting three first tasks were established:

- analysis of available repeated levelling measurements and storage in the data base of the UELN
- development of software as base for test computation
- testing of the principles in a test area (Netherlands, Denmark, northern part of Germany).

The GPS observations of about 80 European permanent stations are available. The analysis of 10 European GPS permanent stations shows daily repeatabilities between 7 to 9 mm in the height component. This is in good agreement with the special GPS height campaigns in Germany for deriving GPS levelling geoidal heights ($m_h = \pm 7$ mm).

Furthermore the linear height regression analysis gives for a three year period an accuracy of a GPS height difference of about

$$m_{V_h} = m_h \sqrt{2} / \sqrt{365} / \text{year} = \pm 0.5 \text{ mm/year}$$

that means from a statistical point of view that a vertical movement of $V_h = 1.0$ mm/year can be significantly determined after a three years GPS observation period ($m_{V_h} = \pm 0.3$ mm/year).

Repeated precise levellings ($1 \text{ mm} \cdot \text{km}^{-1/2}$) with an epoch difference of 20 years give velocities for height differences with an accuracy of about $\pm 0.07 \text{ mm} \cdot \text{km}^{-1/2}/\text{year}$.

From this follows, that GPS permanent stations in a distance of about 300 km can significantly support repeated levellings with above mentioned suppositions. This combination of GPS and levelling is promising for a stable kinematic height reference system (Ihde, 1999).

The observation equation for levelling observations $\Delta h_{ij,k}$ between points i and j at the epoch k is:

$$\Delta h_{ij,k} = H_j - H_i + V_j(t_k - t_0) - V_i(t_k - t_0) \quad (1)$$

Two unknowns per point are to be determined: the levelling height H (gravity related height) at the reference epoch t_0 and the velocity V .

For datum fixing of the network a height for one point at a determined epoch and a velocity for this or another point shall be given. The relation between levelling heights H and GPS heights h is given by the geoid height N

$$h = H + N \quad (2)$$

Since the accuracy of the geoid heights resp. geoid height differences is not in the same order like the levelling observations, GPS heights cannot be used as observations. But under the condition of no significant geoid height changes, velocities v derived from GPS permanent station observations can be used as additional observation type in levelling points i

$$v_i = V_i \quad (3)$$

The unknown velocities V are to be determined in combination with the repeated levellings. It is necessary, that the variance-covariance matrix of the observed GPS velocities is given.

The EVS project has been started in 1999. It would be useful to integrate:

- precise absolute gravity measurements
- sea level monitoring in tide gauge stations.

Excerpt from H. MORITZ:
 Geodetic Reference System 1980
 Bulletin Géodésique, The Geodesists Handbook, 1988,
 International Union of Geodesy and Geophysics

Geodetic Reference System 1980 (GRS80)

The GRS80

- a) based on the theory of the geocentric equipotential ellipsoid, defined by the following conventional constants:
- equatorial radius of the Earth:
 $a = 6378\,137\text{ m}$
 - geocentric gravitational constant of the Earth (including the atmosphere):
 $GM = 3986\,005 \times 10^8\text{ m}^3\text{ s}^{-2}$
 - dynamical form factor of the Earth, excluding the permanent tidal deformation:
 $J_2 = 108\,263 \times 10^{-8}$
 - angular velocity of the Earth:
 $\omega = 7\,292\,115 \times 10^{-11}\text{ rad s}^{-1}$
- b) used the same computational formulas, adopted at the XV General Assembly of IUGG in Moscow 1971 and published by IAG, for the Geodetic Reference System 1967
- c) is orientated in such kind, that the minor axis of the reference ellipsoid, defined above, be parallel to the direction defined by the Conventional International Origin, and that the primary meridian be parallel to the zero meridian of the BIH adopted longitudes.

Definition

Derived Geometrical Constants

$b = 6\,356\,752.3141\text{ m}$	semiminor axis
$e^2 = 0.006\,694\,380\,022\,90$	e = first excentricity
$f = 0.003\,352\,810\,681\,18$	flattening

Derived Physical Constants

$U_0 = 6\,263\,686.0850 \times 10\text{ m}^2\text{ s}^{-2}$	normal potential at ellipsoid
$m = 0.003\,449\,786\,003\,08$	$m = \omega^2 a^2 b/GM$
$\gamma_e = 9.780\,326\,7715\text{ ms}^{-2}$	normal gravity at equator
$\gamma_p = 9.832\,186\,3685\text{ m} \cdot \text{s}^{-2}$	normal gravity at pole
$f^* = 0.005\,302\,440\,112$	$f^* = (\gamma_p - \gamma_e)/\gamma_e$
$k = 0.001\,931\,851\,353$	$k = (b \gamma_e - a \gamma_e)/a \gamma_e$

Numerical Values

Somigliana's closed formula for normal gravity is

$$\gamma_O = \frac{a \gamma_e \cos^2 \phi + b \gamma_p \sin^2 \phi}{\sqrt{a^2 \cos^2 \phi + b^2 \sin^2 \phi}}$$

For numerical computations, the form

$$\gamma_O = \gamma_e \frac{1 + k \sin^2 \phi}{\sqrt{1 - e^2 \sin^2 \phi}}$$

with the values of γ_e , k , and e^2 shown above, is more convenient. ϕ denotes the geographical latitude.

The series expansion

$$\gamma_O = \gamma_e \left(1 + \sum_{n=1}^{\infty} a_{2n} \sin^{2n} \phi \right)$$

Gravity Formula 1980

with

$$a_2 = \frac{1}{2}e^2 + k \quad a_6 = \frac{5}{16}e^6 + \frac{3}{8}e^4 k$$

$$a_4 = \frac{3}{8}e^4 + \frac{1}{2}e^2 k \quad a_8 = \frac{35}{128}e^8 + \frac{5}{16}e^6 k$$

becomes

$$\gamma_O = \gamma_\varepsilon (1 + 0.005\,279\,0414 \sin^2\phi + 0.000\,023\,2718 \sin^4\phi + 0.000\,000\,1262 \sin^6\phi + 0.000\,000\,0007 \sin^8\phi)$$

it has a relative error of 10^{-10} , corresponding to $10^{-3} \mu\text{ms}^{-2} = 10^{-4} \text{mgal}$.

The conventional series

$$\gamma_O = \gamma_e \left(1 + f^* \sin^2\phi - \frac{1}{4} f_4 \sin^2 2\phi \right)$$

with

$$f_4 = -\frac{1}{2}f^2 + \frac{5}{2}f m$$

becomes

$$\gamma_O = 9.780\,327 \left(1 + 0.005\,3024 \sin^2\phi - 0.000\,0058 \sin^2 2\phi \right) \text{ms}^{-2}$$

Origin and Orientation of the Reference System

IUGG Resolution No. 7, quoted at the beginning of this paper, specifies that the Geodetic Reference System 1980 be geocentric, that is, that its origin be the center of mass of the earth. Thus, the center of the ellipsoid coincides with the geocenter.

The orientation of the system is specified in the following way. The rotation axis of the reference ellipsoid is to have the direction of the Conventional International Origin for Polar Motion (CIO), and the zero meridian as defined by the Bureau International de l'Heure (BIH) is used.

To this definition there corresponds a rectangular coordinate system XYZ whose origin is the geocenter, whose Z-axis is the rotation axis of the reference ellipsoid, defined by the direction of CIO, and whose X-axis passes through the zero meridian according to the BIH.

Related Resolutions

Resolution No. 3 of the EUREF Symposium in Warsaw, 8–11 June 1994

The IAG Subcommittee for the European Reference Frame

- *recognizing* the close relationship of vertical datum problems to EUREF activities and
- *considering* the proposal of the EUREF Technical Working Group to respond to an urgent request of CERCO for a European Vertical Datum at the 0.1 m level
- *recommends*
 - that the Technical Working Group undertakes action and reports at the next meeting
 - an enlargement of UELN to Eastern Europe for this purpose
- *requests* the Eastern European agencies to make their national data available for UELN-CRCM Data Centre at Hanover within 1994.

Resolution No. 2 of the EUREF Symposium in Helsinki, 3–6 May 1995

The IAG Subcommittee for the European Reference Frame

- *noting* the resolution No. 3 of the EUREF Warsaw Symposium in 1994 and
- *taking into account* the principals of EPTN and EUVERN proposals presented during this meeting

- *recommends* that a European Vertical Reference Network (EUVN) should be defined as part of the EUREF network with stations co-located with the European levelling or tide gauge networks
- *asks* the EUREF Technical Working Group to organize the determination of the EUVN:
 - by coordinating as many EUREF permanent GPS stations as possible
 - by implementing a suitable GPS campaign to obtain a first epoch determination of all the EUVN stations as soon as possible.

Resolution No. 2 of the EUREF Symposium in Ankara, 22–25 May 1996

The IAG Subcommittee for Europe (EUREF)

- *recognized* that this Subcommittee includes the responsibilities of the former UELN Subcommittee
- *and noting* the increasing need for a unified European height system at the decimetre level
- *decides* to realise such a system through the conversion of the future UELN95 results from geopotential numbers to normal heights.

Resolution No. 3 of the EUREF Symposium in Ankara, 22–25 May 1996

The IAG Subcommittee for Europe (EUREF)

- *noting* the efforts of the European Vertical GPS Reference Network (EUVN) Working Group
- *endorses* their proposal to have a GPS campaign between the 21 and 29 of May, 1997
- *and urges* all EUREF member countries to make their best endeavours in ensuring the success of this campaign.

Resolution No. 4 of the EUREF Symposium in Ankara, 22–25 May 1996

The IAG Subcommittee for Europe (EUREF)

- *recognizing* the progress of UELN95, the forthcoming EUVN GPS Campaign, and the requirements for a continental vertical reference system at the centimetre level
- *decides* to develop a new European geokinematic height reference network with all available kinematic observations (e.g. GPS, levelling, tide gauges, gravity)
- *urges* all EUREF member countries to deliver relevant data to the data centre, Institut für Angewandte Geodäsie (IfAG)
- *and asks* the Technical Working Group to form a special Working Group to oversee the development of the computation method and methodologies.

Resolution No. 3 of the EUREF Symposium in Bad Neuenahr-Ahrweiler, 10–13 June 1998

The IAG Subcommittee for Europe (EUREF)

- *recognizing* the outstanding success of the European Vertical Reference Network 97 (EUVN97) GPS Campaign
- *thanks* the EUVN working group and all the contributors to the campaign
- *accepts* the adjustment presented at the symposium and asks the Technical Working Group to derive the final EUVN 97 GPS coordinates from this adjustment and
- *urges* all EUREF member countries to submit the requested levelling/gravity and tide gauge data, to the data centre in order to achieve the EUVN objectives.

Resolution No. 4 of the EUREF Symposium in Bad Neuenahr-Ahrweiler, 10–13 June 1998

The IAG Subcommittee for Europe (EUREF)

- *recognizing* the progress of the UELN95 project work

- *asks* the data centre and Technical Working Group, to make the solution presented at the symposium, available as the UELN98 solution and
- *urgently requests* the participating countries to make the missing levelling data available, particularly to extend and improve the vertical network to the Black Sea, around the Baltic Sea and including the channel tunnel connection between France and UK.

Resolution No. 1 of the EUREF Symposium in Prague, 2–5 June 1999

The IAG Subcommission for Europe (EUREF)

- *noting* resolution 3 of the EUREF Symposium 1998 in Bad Neuenahr – Ahrweiler
- *accepts* the GPS frame of the European Vertical Reference Network 1997 (EUVN97) as class B standard (about 1 cm at the epoch of observation), and
- *endorses* these results as improvements and extensions to EUREF89.

Resolution No. 5 of the EUREF Symposium in Prague, 2–5 June 1999

The IAG Subcommission for Europe (EUREF)

- *recognizing* the progress in the UELN95 and EUVN as static height networks,
- *accepts* the concept of an integrated kinematic height network for Europe proposed by the Technical Working Group (e.g. GPS permanent stations, repeated levellings, tide gauge observations, repeated gravity measurements)
- *asks* the Technical Working Group to send a circular letter to the EUREF community detailing the proposal and requirements, and seeking participation in all topics (measurements, computing centre, test area).

Resolution No. 3 of the EUREF Symposium in Tromsø, 22–24 June 1999

The IAG Subcommission for Europe (EUREF)

- *noting* resolution 3 of the EUREF Symposium 1998 in Bad Neuenahr-Ahrweiler,
- *recognizing* the completion of the EUVN height solution, which includes GPS/levelling geoid heights,
- *thanks* the National Mapping Agencies for their support in supplying data,
- *recommends* that the GPS/levelling geoid heights of the EUVN solution should be used as fiducial control for future European geoid determinations,
- *asks* the relevant authorities to provide the necessary information for tide gauge connections, to densify the network of EUVN GPS/levelling geoid heights and to complete and extend the EUVN project.

Resolution No. 5 of the EUREF Symposium in Tromsø, 22–24 June 1999

The IAG Subcommission for Europe (EUREF)

- *noting* the recommendation of the spatial referencing workshop, in Marne-la-Vallée 27-30 November 1999, to the European Commission to adopt the results of the EUVN/UELN projects for Europe wide vertical referencing,
- *decides* to define an European Vertical Reference System (EVRS) characterised by the datum of ‘Normaal Amsterdams Peil’ (NAP) and gravity potential differences with respect to NAP or equivalent normal heights,
- *endorses* UELN95/98 and EUVN as realisations of EVRS using the name EVRF2000,
- *asks* the EUREF Technical Working Group to finalise the definition and initial realisation of the EVRS and to make available a document describing the system.

- [1] Adam, J., Augath, W., Brouwer, F., Engelhardt, G., Gurtner, W., Harsson, B. G., Ihde, J., Ineichen, D., Lang, H., Luthardt, J., Sacher, M., Schlüter, W., Springer, T., Wöppelmann, G.: Status and Development of the European Height Systems. In: Proceedings of the IAG General Assembly, Birmingham, July 18-30, 1999, In: IAG Symposia, Vol. 121, Geodesy Begon 2000, Springer, Berlin Heidelberg 2000, p. 55-60.
- [2] Augath, W. (1994): Proposals for a European Task Force on Vertical Datums within the EUREF-Subcommission. Presented at the EUREF Symposium, June 8-10, 1994, Warsaw, Veröffentlichungen der Bayerischen Kommission für die Internationale Erdmessung, Astronomisch-Geodätische Arbeiten, München, 1994, H. 54, p. 171-175.
- [3] Augath, W. (1996): UELN-2000 – Possibilities, Strategy, Concepts – or: How should we realize a European Vertical System? Presented at the EUREF Symposium in Ankara, May 22-25, 1996. Veröffentlichung der Bayerischen Kommission für die Internationale Erdmessung, München, 1996, H. 57, p. 170-174.
- [4] Ekmann, M.: On the Permanent Tide in the European Vertical Reference System. Submitted to the EUREF Technical Working Group, August 2000.
- [5] Ehrnsperger, W., Kok, J.J. (1986): Status and Results of the 1986 Adjustment of the United European Levelling Network - UELN-73. Paper contributed to the Symposium on Height Determination and Recent Crustal Movements in Western Europe, Federal Republic of Germany, Sept. 15-19, 1986.
- [6] Grafarend, E.W., Ardalan, A.A. (1999): World Geodetic Datum 2000. In: Journal of Geodesy (1999) 73, p. 611-623, Springer-Verlag 1999.
- [7] Ihde, J., Schlüter, W.: Proposal for a European Vertical GPS Reference Network (EUVERN). Presented at the EUREF-Symposium in Helsinki, May 3-6, 1995, Veröffentlichungen der Bayerischen Kommission für die Internationale Erdmessung, Astronomisch-Geodätische Arbeiten, München, 1995, H. 56, p. 100-105.
- [8] Ihde, J., Adam, J., Gurtner, W., Harsson, B.G., Schlüter, W., Wöppelmann, G.: The Concept of the European Vertical GPS Reference Network (EUVN). Presented at the EUREF Symposium in Bad Neuenahr-Ahrweiler, June 10-12, 1998, Mitteilungen des Bundesamtes für Kartographie und Geodäsie, Band 7, Frankfurt a. M. 1999, p. 11-22.
- [9] Ihde, J., Adam, J., Gurtner, W., Harsson, B.G., Sacher, M., Schlüter, W., Wöppelmann, G.: The Height Solution of the European Vertical Reference Network (EUVN). Presented at the EUREF Symposium in Tromsø, June 22-24, 2000, in preparation.
- [10] Ineichen, D., Gurtner, W., Springer, T.; Engelhardt, G., Luthardt, J., Ihde, J.: EUVN97-Combined GPS Solution. Presented at the EUREF-Symposium in Bad Neuenahr-Ahrweiler, June 3-5, 1998, Mitteilungen des Bundesamtes für Kartographie und Geodäsie, Band 7, Frankfurt a. M. 1999, p. 23-46.
- [11] Mäkinen, J.: A Note on the treatment of the permanent tidal effect in the European Vertical Reference System (EVRS). Submitted to the EUREF Technical Working Group, August 2000.
- [12] Moritz, H. (1988): Geodetic Reference System 1980. Bulletin Géodésique, The Geodesists Handbook, 1988, International Union of Geodesy and Geophysics.
- [13] Sacher, M., Ihde, J., Seeger, H. (1998): Preliminary Transformation Relations between National European Height Systems and the United European Levelling Network (UELN). Presented at the EUREF Symposium in Prag, June 2-4, 1999, Veröffentlichungen der Bayerischen Kommission für die Internationale Erdmessung, Astronomisch-Geodätische Arbeiten, München, 1999, H. 60, p. 80-86.
- [14] Sacher, M., Ihde, J., Celms, A., Ellmann, A.: The first stage is achieved – further steps are planned. Presented at the EUREF Symposium in Prag, June 2-4, 1999, Veröffentlichungen der Bayerischen Kommission für die Internationale Erdmessung, Astronomisch-Geodätische Arbeiten, München, 1999, H. 60, p. 87-94.

ETRS89 Ellipsoidal Coordinate Reference System (ETRS89)

The European Terrestrial Reference System 1989 (ETRS89) is the geodetic datum for pan-European spatial data collection, storage and analysis. This is based on the GRS80 ellipsoid and is the basis for a coordinate reference system using ellipsoidal coordinates. The ETRS89 Ellipsoidal Coordinate Reference System (ETRS89) is recommended to express and to store positions, as far as possible.

Table 11 contains the fully described ETRS89 Ellipsoidal Coordinate Reference System (ETRS89) following ISO 19111 Spatial referencing by coordinates.

Relationship between ellipsoidal and Cartesian coordinates

The coordinate lines of the ellipsoidal coordinate system are curvilinear lines on the surface of the ellipsoid. They are called parallels for constant latitude (φ) and meridians for constant longitude (λ).

When the ellipsoid is related to the shape of the Earth, the ellipsoidal coordinates are named geodetic coordinates. In some cases the term geographic coordinate system implies a geodetic coordinate system.

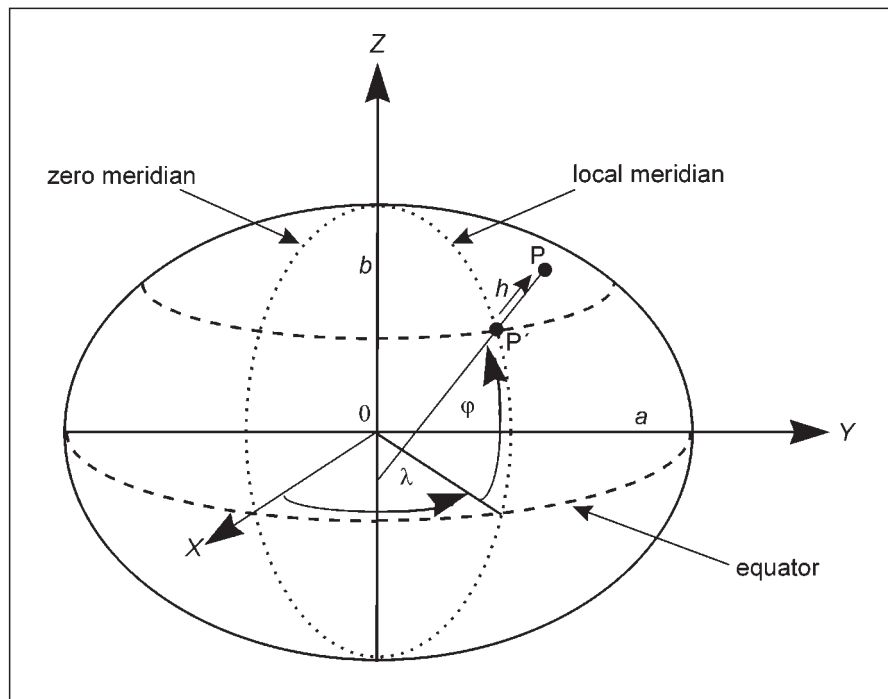

Figure 32:
Cartesian coordinates and ellipsoidal coordinates.

If the origin of a right-handed Cartesian coordinate system coincides with the centre of the ellipsoid, the Cartesian Z-axis coincides with the axis of rotation of the ellipsoid and the positive X-axis passes through the point $\varphi = 0, \lambda = 0$.

Conversion formulas²¹

Symbols and Definitions

φ	geodetic latitude
λ	geodetic longitude
h	ellipsoidal height
X, Y, Z	cartesian coordinates
N	radius of curvature in the prime vertical
e	first numerical eccentricity
a	semi-major axis of the ellipsoid
f	flattening of the ellipsoid

²¹ Source: ISO 19111.

Entitiy	Value
CRS ID	ETRS89
CRS alias	ETRS89 Ellipsoidal CRS
CRS valid area	Europe
CRS scope	Geodesy, Cartography, Geoinformation systems, Mapping
Datum ID	ETRS89
Datum alias	European Terrestrial Reference System 1989
Datum type	geodetic
Datum realization epoch	1989
Datum valid area	Europe/EUREF
Datum scope	European datum consistent with ITRS at the epoch 1989.0 and fixed to the stable part of the Eurasian continental plate for georeferencing of GIS and geokinematic tasks
Datum remarks	see Boucher C., Altamimi Z. (1992): The EUREF Terrestrial Reference System and its First Realizations. Veröffentlichungen der Bayerischen Kommission für die Internationale Erdmessung, Heft 52, München 1992, p. 205-213 or ftp://lareg.ensg.ign.fr/pub/euref/info/guidelines/
Prime meridian ID	Greenwich
Prime meridian Greenwich longitude	0°
Ellipsoid ID	GRS 80
Ellipsoid alias	New International
Ellipsoid semi-major axis	6 378 137 m
Ellipsoid shape	true
Ellipsoid inverse flattening	298.257222101
Ellipsoid remarks	see Moritz, H. (1988): Geodetic Reference System 1980. Bulletin Geodesique, The Geodesists Handbook, 1988, Internat. Union of Geodesy and Geophysics
Coordinate system ID	Ellipsoidal Coordinate System
Coordinate system type	geodetic
Coordinate system dimension	3
Coordinate system axis name	geodetic latitude
Coordinate system axis direction	North
Coordinate system axis unit identifier	degree
Coordinate system axis name	geodetic longitude
Coordinate system axis direction	East
Coordinate system axis unit identifier	degree
Coordinate system axis name	ellipsoidal height
Coordinate system axis direction	up
Coordinate system axis unit identifier	metre

Table 11:
*ETRS89 Ellipsoidal
Coordinate Reference
System Description.*

The following formula converts ellipsoidal coordinates to geocentric Cartesian coordinates:

$$\begin{bmatrix} X \\ Y \\ Z \end{bmatrix} = \begin{bmatrix} [N+h] \cos \varphi \cos \lambda \\ [N+h] \cos \varphi \sin \lambda \\ [N(1-e^2)+h] \sin \varphi \end{bmatrix}$$

with the radius of curvature in the prime vertical (perpendicular to the meridian)

$$N = a(1-e^2 \sin^2 \varphi)^{-1/2}$$

and the first numerical eccentricity of the ellipsoid

$$e = (2f-f^2)^{1/2}$$

The following method converts geocentric Cartesian coordinates to ellipsoidal coordinates:

$$\lambda = \text{arc tan} \frac{Y}{X}$$

(λ is outside the range -90 degrees to +90 degrees if X is negative)

and

$$\varphi_0 = \text{arc tan} \frac{Z}{(1 - e^2)(X^2 + Y^2)^{1/2}}$$

Solve for φ and h by iteration through

$$N_i = a(1 - e^2 \sin^2 \varphi_{i-1})^{-1/2}$$

$$h_i = \frac{(X^2 + Y^2)^{1/2}}{\cos \varphi_{i-1}} - N_i \text{ for } |\varphi_0| < 45^\circ \text{ and } h_i = \frac{Z}{\sin \varphi_{i-1}} - (1 - e^2)N_i \text{ for } |\varphi_0| \geq 45^\circ$$

$$\varphi_i = \text{arc tan} \left[\frac{Z}{(X^2 + Y^2)^{1/2}} \cdot \frac{1}{1 - \frac{e^2 N_i}{N_i + h_i}} \right]$$

It is also possible to use closed formulas for conversion of Cartesian to ellipsoidal coordinates and vice versa. The formulas can be found e.g. GDA Technical Manual from Australia's National Mapping Agency (www.auslig.gov.au)²².

<p>Ellipsoidal to Cartesian</p> $X = (v + h) \cos \varphi \cos \lambda$ $Y = (v + h) \cos \varphi \sin \lambda$ $Z = \{(1 - e^2)v + h\} \sin \varphi$	<p>where:</p> $v = a / \{(1 - e^2 \sin^2 \varphi)^{1/2}\}$ $e^2 = 2f - f^2$
<p>Cartesian to ellipsoidal</p> $\tan \lambda = Y/X$ $\tan \varphi = (Z(1 - f) + e^2 a \sin^3 u) / \{(1 - f)(p - e^2 a \cos^3 u)\}$ $h = p \cos \varphi + Z \sin \varphi - a(1 - e^2 \sin^2 \varphi)^{1/2}$	<p>where:</p> $p = (X^2 + Y^2)^{1/2}$ $\tan u = (Z/p) [(1 - f) + (e^2 a/r)]$ $r = (p^2 + Z^2)^{1/2}$

²² modified regarding same symbols like ISO 19111.

ETRS89 Transverse Mercator Coordinate Reference System (*ETRS-TMzn*)

The European Terrestrial Reference System 1989 (ETRS89) is the geodetic datum for pan-European spatial data collection, storage and analysis. This is based on the GRS80 ellipsoid and is the basis for a coordinate reference system using ellipsoidal coordinates. For many pan-European purposes a plane coordinate system is preferred. But the mapping of ellipsoidal coordinates to plane coordinates cannot be made without distortion in the plane coordinate system. Distortion can be controlled, but not avoided. For many purposes the plane coordinate system should have minimum distortion of scale and direction. This can be achieved through a conformal map projection.

The ETRS89 Transverse Mercator Coordinate Reference System (ETRS-TMzn) is recommended for conformal pan-European mapping at scales larger than 1:500,000. For pan-European conformal mapping at scales smaller or equal 1:500,000 the ETRS89 Lambert Conformal Conic Coordinate Reference System (ETRS-LCC) is recommended.

With conformal projection methods attributes such as area will not be distortion-free. For pan-European statistical mapping at all scales or other purposes where true area representation is required, the ETRS89 Lambert Azimuthal Equal Area Coordinate Reference System is recommended.

The ETRS89 Transverse Mercator Coordinate Reference System (ETRS-TMzn) is identical to the Universal Transverse Mercator grid system for the northern Hemisphere applied to the ETRS89 geodetic datum and the GRS80 ellipsoid. The UTM system was developed for worldwide application between 80° S and 84° N with the following basic features:

- a) 60 zones of 6° longitudinal extension numbered consecutively from 1 to 60, beginning with number 1 for the zone between 180° W and 174° W and continuing eastward
- b) central meridian scale factor of 0.9996 producing two lines of secancy approximately 180 000 m East and West of the central meridian
- c) negative coordinates are avoided by assigning a false easting value of 500 000 m East at the central meridian; and false northing values at the equator of 0 m for the northern hemisphere and 10 000 000 m for the southern hemisphere
- d) uniform conversion formulas from one zone to another
- e) unique referencing for all zones in a plane rectangular coordinate system
- f) meridional convergence (between the true and grid North) to be less than 5°
- g) map distortion within the zones to be less than 1:2,500

ETRS-TMzn is a series of zones, where “zn” in the identifier is the zone number. Each zone runs from the equator northwards to latitude 84° North and is 6-degrees wide in longitude reckoned from the Greenwich prime meridian. Zone 31 is centred on 3° East and is used between 0° and 6° East, zone 32 is centred on 9° East and is used between 6° and 12° East, etc.

Table 11 shows the zones of the ETRS-TMzn.

Table 12 contains the fully described ETRS89 Transverse Mercator Coordinate Reference System (ETRS-TMzn) following ISO 19111 Spatial referencing by coordinates.

Table 11:
Zones of ETRS89 Transverse
Mercator Coordinate
Reference System.

Zone number (zn)	Longitude of Origin (degrees)	West Limit (degrees)	East Limit (degrees)	South Limit (degrees)	North Limit (degrees)
26	27° West	30° West	24° West	0° North	84° North
27	21° West	24° West	18° West	0° North	84° North
28	15° West	18° West	12° West	0° North	84° North
29	9° West	12° West	6° West	0° North	84° North
30	3° West	6° West	0° East	0° North	84° North
31	3° East	0° East	6° East	0° North	84° North
32	9° East	6° East	12° East	0° North	84° North
33	15° East	12° East	18° East	0° North	84° North
34	21° East	18° East	24° East	0° North	84° North
35	27° East	24° East	30° East	0° North	84° North
36	33° East	30° East	36° East	0° North	84° North
37	39° East	36° East	42° East	0° North	84° North
38	45° East	42° East	48° East	0° North	84° North
39	51° East	48° East	54° East	0° North	84° North

Table 12:
ETRS-TMzn Description

Entity	Value
CRS ID	ETRS-TMzn
CRS remarks	zn is the zone number, starting with 1 on the zone from 180° West to 174° West, increasing eastwards to 60 on the zone from 174° East to 180° East
CRS alias	ETRS89 Transverse Mercator CRS
CRS valid area	Europe
CRS scope	CRS for conformal pan-European mapping at scales larger than 1:500,000
Datum ID	ETRS89
Datum alias	European Terrestrial Reference System 1989
Datum type	geodetic
Datum realization epoch	1989
Datum valid area	Europe/EUREF
Datum scope	European datum consistent with ITRS at the epoch 1989.0 and fixed to the stable part of the Eurasian continental plate for georeferencing of GIS and geokinematic tasks
Datum remarks	see Boucher, C., Altamimi, Z. (1992): The EUREF Terrestrial Reference System and its First Realizations. Veröffentlichungen der Bayerischen Kommission für die Internationale Erdmessung, Heft 52, München 1992, pages 205-213 or ftp://lareg.ensg.ign.fr/pub/euref/info/guidelines/
Prime meridian ID	Greenwich
Prime meridian Greenwich longitude	0°
Ellipsoid ID	GRS 80
Ellipsoid alias	New International
Ellipsoid semi-major axis	6 378 137 m
Ellipsoid shape	true
Ellipsoid inverse flattening	298.257222101
Ellipsoid remarks	see Moritz, H. (1988): Geodetic Reference System 1980. Bulletin Geodesique, The Geodesists Handbook, 1988, Internat. Union of Geodesy and Geophysics

Entity	Value
Coordinate system ID	TMzn
Coordinate system type	Projected
Coordinate system dimension	2
Coordinate system remarks	Projection: Transverse Mercator in zones, 6° width
Coordinate system axis name	N
Coordinate system axis direction	North
Coordinate system axis unit identifier	Metre
Coordinate system axis name	E
Coordinate system axis direction	East
Coordinate system axis unit identifier	Metre
Operation ID	TMzn
Operation valid area	Europe
Operation scope	for conformal pan-European mapping at scales larger than 1:500,000
Operation method name	Transverse Mercator Projection
Operation method name alias	TMzn
Operation method formula	Transverse Mercator Mapping Equations, in Hooijberg, Practical Geodesy, 1997, pages 81-84, 111-114
Operation method parameters number	7
Operation parameter name	latitude of origin
Operation parameter value	0°
Operation parameter remarks	0°, the Equator
Operation parameter name	longitude of origin
Operation parameter value	central meridian (CM) of each zone
Operation parameter remarks	central meridians ...,3° W, 3° E, 9° E, 15° E, 21° E,...
Operation parameter name	false northing
Operation parameter value	0 m
Operation parameter remarks	
Operation parameter name	false easting
Operation parameter value	500 000 m
Operation parameter remarks	
Operation parameter name	scale factor at central meridian
Operation parameter value	0.9996
Operation parameter remarks	
Operation parameter name	width of zones
Operation parameter value	6°
Operation parameter remarks	
Operation parameter name	latitude limits of system
Operation parameter value	0° N and 84° N
Operation parameter remarks	

Table 12:
(continued)

Note that the axes abbreviations for ETRS-TMzn and ETRS-LCC are N and E whilst for the ETRS-LAEA they are Y and X.

It exist different formulas for Transverse Mercator Projection. Formulas can be found in:

- Hooijberg, Marten: Practical Geodesy, Springer Verlag Berlin Heidelberg New York 1997, pages 81-84 (see below in this paper)
- Krüger L: Konforme Abbildung des Erdellipsoids in der Ebene, B.G. Teubner Verlag Leipzig 1912, pages 11-22
- Poder, K.; Engsager, K.: Some Conformal Mappings and Transformations for Geodesy and Topographic Cartography, Publications 4 series, volume 6, National Survey and Cadastre Denmark, 1998
- König, R.; Weise, K.H.: Mathematische Grundlagen der höheren Geodäsie und Kartographie, Springer Verlag Berlin Göttingen Heidelberg, 1951.

Conversion formulas²³

Symbols and Definitions (all angles are expressed in radians)

a	semi-major axis of the ellipsoid	
b	semi-minor axis of the ellipsoid	
f	flattening of the ellipsoid	
k ₀	(grid) scale factor assigned to the central meridian	
φ ₀	parallel of geodetic latitude (grid) origin	
λ ₀	central meridian (CM)	
E ₀	false easting (constant assigned to the CM)	
N ₀	false northing (constant assigned to the latitude of grid origin)	
φ	parallel of geodetic latitude, positive North	
λ	meridian of geodetic longitude, positive East	
E	easting coordinate on the projection	
N	northing coordinate on the projection	
γ	meridian convergence	
k	point grid scale factor	
ω	rectifying meridional arc	
S	meridional distance	
S ₀	meridional distance from the equator to φ ₀ , multiplied by the CM scale factor	
ΔN	N ₂ – N ₁ – difference in northing	
ΔE	E ₂ – E ₁ – difference in eastings	
E'	E – E ₀	
e ²	first eccentricity squared	e ² = 2 f – f ²
e' ²	second eccentricity squared	e' ² = e ² /(1–e ²)
n	second flattening	n = f/(2 – f)
R	radius of curvature in the Prime Vertical	
r ₀	geometric mean radius of curvature scaled to the grid	
r	radius of the rectifying sphere	
t	tan φ	
t _f	grid azimuth	
η ²	e' ² cos ² φ	
η _f ²	e' ² cos ² φ _f	

Constants for Meridional Arc

Compute constants for meridional arc as given below

$$c = \frac{a}{(1 - e^2)^{1/2}}$$

$$r = \frac{a(1 + n^2 / 4)}{(1 + n)}$$

$$U_0 = c \left[\left(\left(\left(-\frac{86625}{8} e'^2 + 11025 \right) \frac{e'^2}{64} - 175 \right) \frac{e'^2}{4} + 45 \right) \frac{e'^2}{16} - 3 \right] \frac{e'^2}{4}$$

$$U_2 = c \left[\left(\left(\left(-\frac{17325}{4} e'^2 + 3675 \right) \frac{e'^2}{256} - \frac{175}{12} \right) e'^2 + 15 \right) \frac{e'^4}{32} \right]$$

$$U_4 = c \left[-\frac{1493}{2} + 735 e'^2 \right] \frac{e'^6}{2048}$$

$$U_6 = c \left[\left(-\frac{3465}{4} e'^2 + 315 \right) \frac{e'^8}{1024} \right]$$

$$V_0 = \left(\left(\left((16384 e'^2 - 11025) \frac{e'^2}{64} + 175 \right) \frac{e'^2}{4} - 45 \right) \frac{e'^2}{16} + 3 \right) \frac{e'^2}{4}$$

$$V_2 = \left(\left(\left(-\frac{20464721}{120} e'^2 + 19413 \right) \frac{e'^2}{8} - 1477 \right) \frac{e'^2}{32} + 21 \right) \frac{e'^4}{32}$$

²³ Formulas after Hooijberg, Marten: Practical Geodesy, Springer Verlag Berlin Heidelberg New York 1997, pages 81-84.

$$V_4 = \left(\left(\frac{4737141}{28} e'^2 - 17121 \right) \frac{e'^2}{32} + 151 \right) \frac{e'^6}{192}$$

$$V_6 = \left(-\frac{427277}{35} e'^2 + 1097 \right) \frac{e'^8}{1024}$$

$$\begin{aligned} \omega_0 &= \varphi_0 r + \sin \varphi_0 \cos \varphi_0 (U_0 + U_2 \cos^2 \varphi_0 + U_4 \cos^4 \varphi_0 + U_6 \cos^6 \varphi_0) \\ S_0 &= k_0 \omega_0 \end{aligned}$$

Meridional Arc
formulas

Input: geodetic coordinates of a point P (φ, λ)

Output: grid coordinates of a point P (E,N)

$$L = (\lambda - \lambda_0) \cos \varphi$$

$$\omega = \varphi r + \sin \varphi \cos \varphi (U_0 + U_2 \cos^2 \varphi + U_4 \cos^4 \varphi + U_6 \cos^6 \varphi)$$

$$S = k_0 \omega$$

$$R = \frac{k_0 a}{(1 - e^2 \sin^2 \varphi)^{1/2}}$$

$$A_1 = R$$

$$A_3 = \frac{1}{6} (1 - t^2 + \eta^2)$$

$$A_5 = \frac{1}{120} (5 - 18 t^2 + t^4 + \eta^2 (14 - 58 t^2))$$

$$A_7 = \frac{1}{5040} (61 - 479 t^2 + 179 t^4 - t^6)$$

$$A_2 = \frac{1}{2} R t$$

$$A_4 = \frac{1}{12} [5 - t^2 + \eta^2 (9 + 4 \eta^2)]$$

$$A_6 = \frac{1}{360} [61 - 58 t^2 + t^4 + \eta^2 (270 - 330 t^2)]$$

$$E = E_0 + A_1 L [1 + L^2 (A_3 + L^2 (A_5 + A_7 L^2))]$$

$$N = S - S_0 + N_0 + A_2 L^2 (1 + L^2 (A_4 + A_6 L^2))$$

Direct Computation

Input: grid coordinates of a point P (E, N)

Output: geodetic coordinates P (φ, λ)

$$\omega = \frac{N - N_0 + S_0}{k_0 r}$$

$$\varphi_f = \omega + (\sin \omega \cos \omega) (V_0 + V_2 \cos^2 \omega + V_4 \cos^4 \omega + V_6 \cos^6 \omega)$$

$$R_f = \frac{k_0 a}{(1 - e^2 \sin^2 \varphi_f)^{1/2}}$$

$$Q = \frac{E'}{R_f} \quad \text{in which } E' = E - E_0$$

$$B_2 = -\frac{1}{2} t_f (1 + \eta_f^2)$$

$$B_4 = -\frac{1}{12} [5 + 3 t_f^2 + \eta_f^2 (1 - 9 t_f^2) - 4 \eta_f^4]$$

Inverse Computation

$$B_6 = \frac{1}{360} [61 + 90 t_f^2 + 45 t_f^4 + \eta_f^2 (46 - 252 t_f^2 - 90 t_f^4)]$$

$$B_3 = -\frac{1}{6} (1 + 2 t_f^2 + \eta_f^2)$$

$$B_5 = \frac{1}{120} [5 + 28 t_f^2 + 24 t_f^4 + \eta_f^2 (6 + 8 t_f^2)]$$

$$B_7 = -\frac{1}{5040} (61 + 662 t_f^2 + 1320 t_f^4 + 720 t_f^6)$$

$$\varphi = \varphi_f + B_2 Q^2 [1 + Q^2 (B_4 + B_6 Q^2)]$$

$$L = Q [1 + Q^2 (B_3 + Q^2 (B_5 + B_7 Q^3))]$$

$$\lambda = \lambda_0 + L/\cos \varphi_f$$

Examples

ETRS89	geodetic latitude:	50°00'00.000"N	geodetic longitude:	5°00'00.000"E
ETRS-TM31	northing (N):	5 540 547.37 m	easting (E):	643 329.12 m
ETRS89	geodetic latitude:	60°00'00.000"N	geodetic longitude:	5°00'00.000"E
ETRS-TM31	northing (N):	6 653 097.44 m	easting (E):	611 544.04 m

ETRS89 Lambert Conformal Conic Coordinate Reference System (ETRS-LCC)

The European Terrestrial Reference System 1989 (ETRS89) is the geodetic datum for pan-European spatial data collection, storage and analysis. This is based on the GRS80 ellipsoid and is the basis for a coordinate reference system using ellipsoidal coordinates. For many pan-European purposes a plane coordinate system is preferred. But the mapping of ellipsoidal coordinates to plane coordinates cannot be made without distortion in the plane coordinate system. Distortion can be controlled, but not avoided. For many purposes the plane coordinate system should have minimum distortion of scale and direction. This can be achieved through a conformal map projection.

The ETRS89 Lambert Conformal Conic Coordinate Reference System (ETRS-LCC) is recommended for conformal pan-European mapping at scales smaller or equal 1:500,000. For pan-European conformal mapping at scales larger than 1:500,000 the ETRS89 Transverse Mercator Coordinate Reference System (ETRS-TMzn) is recommended.

With conformal projection methods attributes such as area will not be distortion-free. For pan-European statistical mapping at all scales or other purposes where true area representation is required, the ETRS89 Lambert Azimuthal Equal Area Coordinate Reference System is recommended.

The ETRS89 Lambert Conformal Conic Coordinate Reference System (ETRS-LCC) is a single projected coordinate reference system for all of the pan-European area applied to the ETRS89 geodetic datum and the GRS80 ellipsoid. Because of the greater extent in longitude than in latitude, a Lambert Conic Conformal projection with two standard parallels is utilised.

The scale factor is only a function of the latitudes of the standard parallels and the latitude of the point where it is computed. The Figure 33 shows the variation of the scale factor k against latitude. The maximum and minimum values are shown in Table 13, also in parts per million (ppm).

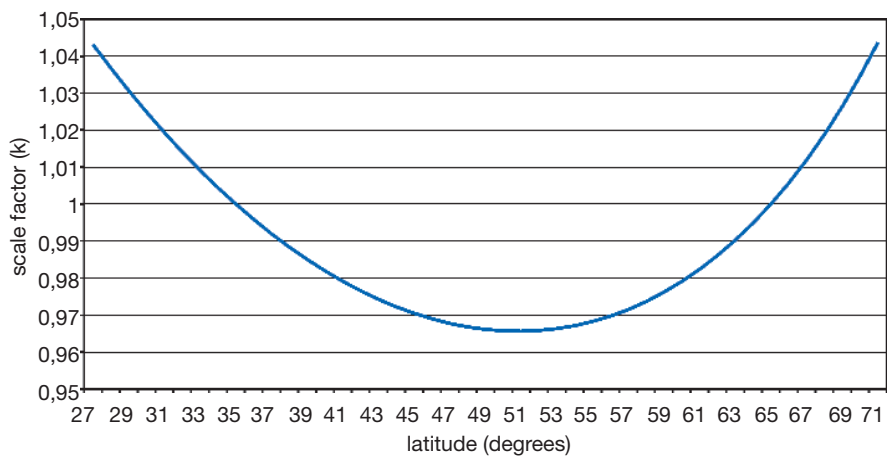

Figure 33: Variation of the scale factor (k) against latitude.

extreme	latitude	Scale factor k	Scale (ppm)
minimum	51°N (circa)	0.965 622	-34 378
maximum	71° N	1.043 704	43 704

Table 13: Maximum and minimum values of the distortion.

Table 14 shows the extreme values for northing and easting in Europe:

Table 14:
Extreme values for northing
and easting.

Extreme	Point		northing (m)	easting (m)
Min. E	27° N	30° W	1 144 833.592	58 028.386
Max. E	27° N	45° E	893 308.351	7 489 639.219
Min. N	27° N	10° E	51 062.622	4 000 000.000
Max. N	71° N	30° W	5 298 732.738	2 555 449.197

Defining parameters are given in Table 15 following ISO 19111 Spatial referencing by coordinates.

Table 15:
ETRS-LCC Description.

Entity	Value
CRS ID	ETRS-LCC
CRS alias	ETRS89 Lambert Conformal Conic CRS
CRS valid area	Europe
CRS scope	CRS for conformal pan-European mapping at scales smaller or equal 1:500,000
Datum ID	ETRS89
Datum alias	European Terrestrial Reference System 1989
Datum type	geodetic
Datum realization epoch	1989
Datum valid area	Europe/EUREF
Datum scope	European datum consistent with ITRS at the epoch 1989.0 and fixed to the stable part of the Eurasian continental plate for georeferencing of GIS and geokinematic tasks
Datum remarks	see Boucher, C., Altamimi, Z. (1992): The EUREF Terrestrial Reference System and its First Realizations. Veröffentlichungen der Bayerischen Kommission für die Internationale Erdmessung, Heft 52, München 1992, pages 205-213 or ftp://lareg.ensg.ign.fr/pub/euref/info/guidelines/
Prime meridian ID	Greenwich
Prime meridian Greenwich longitude	0°
Ellipsoid ID	GRS 80
Ellipsoid alias	New International
Ellipsoid semi-major axis	6 378 137 m
Ellipsoid shape	True
Ellipsoid inverse flattening	298.257222101
Ellipsoid remarks	see Moritz, H. (1988): Geodetic Reference System 1980. Bulletin Geodesique, The Geodesists Handbook, 1988, Internat. Union of Geodesy and Geophysics
Coordinate system ID	LCC
Coordinate system type	Projected
Coordinate system dimension	2
Coordinate system axis name	N
Coordinate system axis direction	North
Coordinate system axis unit identifier	Metre
Coordinate system axis name	E
Coordinate system axis direction	East
Coordinate system axis unit identifier	metre
Operation ID	LCC
Operation valid area	Europe
Operation scope	for conformal pan-European mapping at scales smaller or equal 1:500,000
Operation method name	Lambert Conformal Conic Projection with 2 standard parallels
Operation method formula	Lambert Conformal Conic Projection, in Hooijberg, Practical Geodesy, 1997, pages 133-139
Operation method parameters number	6
Operation parameter name	lower parallel
Operation parameter value	35° N

²⁴ Note that the axes abbreviations for ETRS-LCC and ETRS-TMzn are N and E whilst for the ETRS-LAEA they are Y and X.

Entity	Value
Operation parameter remarks	
Operation parameter name	upper parallel
Operation parameter value	65° N
Operation parameter remarks	
Operation parameter name	latitude grid origin
Operation parameter value	52° N
Operation parameter remarks	
Operation parameter name	longitude grid origin
Operation parameter value	10° E
Operation parameter remarks	
Operation parameter name	false northing
Operation parameter value	2 800 000 m
Operation parameter remarks	
Operation parameter name	false easting
Operation parameter value	4 000 000 m
Operation parameter remarks	

Table 15:
(continued)

Symbols and Definitions (all angles are expressed in radians)

- a semi-major axis of the ellipsoid
- b semi-minor axis of the ellipsoid
- f flattening of the ellipsoid
- e^2 first eccentricity squared $e^2 = 2f - f^2$
- φ_u upper parallel
- φ_l lower parallel
- φ_b latitude of (false) grid origin in case of 2 parallels
- k_0 point scale factor at central parallel (CP)
- λ_0 longitude grid origin, central reference meridian (RM, λ_0),
- E_0 false easting
- N_0 false northing
- R mapping radius at latitude φ
- K mapping radius at the equator
- Q isometric latitude
- φ parallel of geodetic latitude, positive North
- λ meridian of geodetic longitude, positive East
- E easting coordinate
- N northing coordinate
- γ convergence angle
- k grid scale factor at a general point

Conversion formulas²⁵

Constants and expressions within Lambert's conical mapping equations are ellipsoid and zone specific.

$$Q_1 = \frac{1}{2} \left[\ln \left(\frac{1 + \sin \varphi_1}{1 - \sin \varphi_1} \right) - e \ln \left(\frac{1 + e \sin \varphi_1}{1 - e \sin \varphi_1} \right) \right]$$

$$W_1 = (1 - e^2 \sin^2 \varphi_1)^{1/2}$$

Similarly for Q_u , Q_b , and W_u upon substitution of the appropriate latitude.

$$\sin \varphi_0 = \frac{\ln \left(\frac{W_u \cos \varphi_l}{W_1 \cos \varphi_u} \right)}{Q_u - Q_1}$$

Computation of Projection Zone and Ellipsoid Constants

²⁵ Source: Hooijberg, Marten: Practical Geodesy, Springer Verlag Berlin Heidelberg New York 1997, pages 136-137, modified for 2 parallels.

$$K = \frac{a \cos \varphi_1 \exp(Q_1 \sin \varphi_0)}{W_1 \sin \varphi_0}$$

$$= \frac{a \cos \varphi_u \exp(Q_u \sin \varphi_0)}{W_u \sin \varphi_0}$$

$$R_0 = \frac{K}{\exp(Q_b \sin \varphi_0)}$$

Note: $\exp(x) = e^x$, in which $e = 2.71828\ 18284\ 59045\ 23536\ 02875$
(base of natural logarithms)

$$\ln(\tan(\pi/4 + \varphi/2)) = \frac{1}{2} \ln\left(\frac{1 + \sin \varphi}{1 - \sin \varphi}\right)$$

Direct Conversion Computation

Input: geodetic coordinates of point P (φ, λ)

Output: grid coordinates of point P (E, N), convergence angle (γ), scale factor (k)

$$Q = \frac{1}{2} \left[\ln\left(\frac{1 + \sin \varphi}{1 - \sin \varphi}\right) - e \ln\left(\frac{1 + e \sin \varphi}{1 - e \sin \varphi}\right) \right]$$

$$R = \frac{K}{\exp(Q \sin \varphi_0)}$$

$$E = E_0 - R \sin \gamma$$

$$N = R_0 + N_0 - R \cos \gamma$$

$$\gamma = (\lambda_0 - \lambda) \sin \varphi_0$$

$$k = (1 - e^2 \sin^2 \varphi)^{1/2} \frac{(R \sin \varphi_0)}{(a \cos \varphi)}$$

Inverse Conversion Computation

Input: grid coordinates of a point P (E, N)

Output: geodetic coordinates P (φ, λ), convergence angle (γ)

$$R' = R_0 - N + N_0$$

$$E' = E_0 - E$$

$$\gamma = \tan^{-1}(E'/R')$$

$$\lambda = \lambda_0 - \frac{\gamma}{\sin \varphi_0}$$

$$R = (R'^2 + E'^2)^{1/2}$$

$$Q = \frac{\ln(K/R)}{\sin \varphi_0}$$

Use an approximation for φ as follows

$$\sin \varphi = \frac{\exp(2Q) - 1}{\exp(2Q) + 1} \quad \text{and iterate } \sin \varphi \text{ as follows:}$$

$$f_1 = \frac{1}{2} \left[\ln\left(\frac{1 + \sin \varphi}{1 - \sin \varphi}\right) - e \ln\left(\frac{1 + e \sin \varphi}{1 - e \sin \varphi}\right) \right]$$

$$f_2 = \frac{1}{(1 - \sin^2 \varphi)} - \frac{e^2}{(1 - e^2 \sin^2 \varphi)}$$

$\sin \varphi = \sin \varphi + (-f_1/f_2)$ and iterate to obtain φ with sufficient accuracy

Examples

ETRS89	geodetic latitude:	50°00'00.000"N	geodetic longitude:	5°00'00.000"E
ETRS-LCC	northing (N):	2 596 848.66 m	easting (E)	3 654 072.12 m
ETRS89	geodetic latitude:	60°00'00.000"N	geodetic longitude:	5°00'00.000"E
ETRS-LCC	northing (N):	3 673 790.20 m	easting (E)	3 727 054.58 m

ETRS89 Lambert Azimuthal Equal Area Coordinate Reference System (*ETRS-LAEA*)

The European Terrestrial Reference System 1989 (ETRS89) is the geodetic datum for pan-European spatial data collection, storage and analysis. This is based on the GRS80 ellipsoid and is the basis for a coordinate reference system using ellipsoidal coordinates. For many pan-European purposes a plane coordinate system is preferred. But the mapping of ellipsoidal coordinates to plane coordinates cannot be made without distortion in the plane coordinate system. Distortion can be controlled, but not avoided.

For many purposes the plane coordinate system should have minimum distortion of scale and direction. This can be achieved through a conformal map projection. The ETRS89 Transverse Mercator Coordinate Reference System (ETRS-TMzn) is recommended for conformal pan-European mapping at scales larger than 1:500,000. For pan-European conformal mapping at scales smaller or equal 1:500,000 the ETRS89 Lambert Conformal Conic Coordinate Reference System (ETRS-LCC) is recommended.

With conformal projection methods attributes such as area will not be distortion-free. For pan-European statistical mapping at all scales or for other purposes where true area representation is required, the ETRS89 Lambert Azimuthal Equal Area Coordinate Reference System (ETRS-LAEA) is recommended.

The ETRS89 Lambert Azimuthal Equal Area Coordinate Reference System (ETRS-LAEA) is a single projected coordinate reference system for all of the pan-European area. It is based on the ETRS89 geodetic datum and the GRS80 ellipsoid. Its defining parameters are given in Table 16 following ISO 19111 Spatial referencing by coordinates.

With these defining parameters, locations North of 25° have positive grid northing and locations eastwards of 30° West longitude have positive grid easting. Note that the axes abbreviations for ETRS-LAEA are Y and X whilst for the ETRS-LCC and ETRS-TMnz they are N and E.

Entity	Value
CRS ID	ETRS-LAEA
CRS alias	ETRS89 Lambert Azimuthal Equal Area CRS
CRS valid area	Europe
CRS scope	CRS for pan-European statistical mapping at all scales or other purposes where true area representation is required
Datum ID	ETRS89
Datum alias	European Terrestrial Reference System 1989
Datum type	geodetic
Datum realization epoch	1989
Datum valid area	Europe/EUREF
Datum scope	European datum consistent with ITRS at the epoch 1989.0 and fixed to the stable part of the Eurasian continental plate for georeferencing of GIS and geokinematic tasks
Datum remarks	see Boucher, C., Altamimi, Z. (1992): The EUREF Terrestrial Reference System and its First Realizations. Veröffentlichungen der Bayerischen Kommission für die Internationale Erdmessung, Heft 52, München 1992, pages 205-213 - or - ftp://lareg.ensg.ign.fr/pub/euref/info/guidelines
Prime meridian ID	Greenwich
Prime meridian Greenwich longitude	0°
Ellipsoid ID	GRS 80
Ellipsoid alias	New International
Ellipsoid semi-major axis	6 378 137 m
Ellipsoid shape	true
Ellipsoid inverse flattening	298.257222101
Ellipsoid remarks	see Moritz, H. (1988): Geodetic Reference System 1980. Bulletin Geodesique, The Geodesists Handbook, 1988, Internat. Union of Geodesy and Geophysics

Table 16:
ETRS-LAEA Description.

Table 16:
(continued).

Entity	Value
Coordinate system ID	LAEA
Coordinate system type	projected
Coordinate system dimension	2
Coordinate system axis name	Y
Coordinate system axis direction	North
Coordinate system axis unit identifier	metre
Coordinate system axis name	X
Coordinate system axis direction	East
Coordinate system axis unit identifier	metre
Operation ID	LAEA
Operation valid area	Europe
Operation scope	for pan-European statistical mapping at all scales or other purposes where true area representation is required
Operation method name	Lambert Azimuthal Equal Area Projection
Operation method formula	US Geological Survey Professional Publication 1395, "Map Projection – A Working Manual" by John P. Snyder
Operation method parameters number	4
Operation parameter name	latitude of origin
Operation parameter value	52° N
Operation parameter name	longitude of origin
Operation parameter value	10° E
Operation parameter remarks	
Operation parameter name	false northing
Operation parameter value	3 210 000.0 m
Operation parameter remarks	
Operation parameter name	false easting
Operation parameter value	4 321 000.0 m
Operation parameter remarks	

Conversion formulas²⁶

Symbols and Definitions (all angles are expressed in radians)

- a semi-major axis of the ellipsoid
- f flattening of the ellipsoid
- e^2 first eccentricity squared $e^2 = 2f - f^2$
- φ is the latitude of the point to be converted, positive if North and negative if South of the equator
- λ is the longitude of the point to be converted, positive if East and negative if West of the prime meridian (Greenwich)
- φ_0 is the latitude of the natural origin
- λ_0 is the longitude of the natural origin (with respect to the prime meridian Greenwich)
- X_0 false easting, the eastings value assigned to the natural origin
- Y_0 false northing, the northings value assigned to the natural origin
- X easting coordinate measured from the grid origin
- Y northing coordinate measured from the grid origin

Direct Conversion Computation

To derive the projected coordinates of a point, geodetic latitude (φ) is converted to authalic latitude (β). The formulas to convert geodetic latitude and longitude (φ, λ) to northing (Y) and easting (X) are:

$$q = (1 - e^2) \left\{ \frac{\sin \varphi}{(1 - e^2 \sin^2 \varphi)} - \frac{1}{2e} \ln \left(\frac{1 - e \sin \varphi}{1 + e \sin \varphi} \right) \right\}$$

$$q_0 = (1 - e^2) \left\{ \frac{\sin \varphi_0}{(1 - e^2 \sin^2 \varphi_0)} - \frac{1}{2e} \ln \left(\frac{1 - e \sin \varphi_0}{1 + e \sin \varphi_0} \right) \right\}$$

²⁶ Formulas after John P. Snyder, US Geological Survey Professional Publication 1395, "Map Projection – A Working Manual".

$$q_p = (1 - e^2) \left\{ \frac{1}{(1 - e^2)} - \frac{1}{2e} \ln \left(\frac{1 - e}{1 + e} \right) \right\}$$

$$\beta = \arcsin (q/q_p)$$

$$\beta_0 = \arcsin (q_0/q_p)$$

$$R_q = a(q_p/2)^{1/2}$$

$$D = \frac{a \cos \varphi_0}{(1 - e^2 \sin^2 \varphi_0)^{1/2} (R_q \cos \beta_0)}$$

$$B = R_q \frac{2}{[1 + \sin \beta_0 \sin \beta + \cos \beta_0 \cos \beta \cos (\lambda - \lambda_0)]^{1/2}}$$

$$\text{northing, } Y = Y_0 + (B/D) \{(\cos \beta_0 \sin \beta) - [\sin \beta_0 \cos \beta \cos (\lambda - \lambda_0)]\}$$

$$\text{easting, } X = X_0 + \{(B/D) [\cos \beta \sin (\lambda - \lambda_0)]\}$$

The reverse formulas to derive the geodetic latitude and longitude of a point from its northing and easting values are:

$$\beta' = \arcsin \{ \cos C \sin \beta_0 + (D (Y - Y_0) \sin C \cos \beta_0) / \rho \}$$

$$\rho = \left[\left(\frac{X - X_0}{D} \right)^2 + (D (Y - Y_0))^2 \right]^{1/2}$$

$$C = 2 \arcsin \left(\frac{\rho}{2R_q} \right)$$

and D, R_q, and β₀ are as in the previous equations.

$$\varphi = \beta' + \left[\left(\frac{e^2}{3} + \frac{31e^4}{180} + \frac{517e^6}{5040} \right) \sin 2\beta' \right] + \left[\left(\frac{23e^4}{360} + \frac{251e^6}{3780} \right) \sin 4\beta' \right] + \left[\left(\frac{761e^6}{45360} \right) \sin 6\beta' \right]$$

$$\lambda = \lambda_0 + \arctan \left(\frac{(X - X_0) \sin C}{D \rho \cos \beta_0 \cos C - D^2 (Y - Y_0) \sin \beta_0 \sin C} \right)$$

ETRS89	geodetic latitude:	50°00'00.000"N	geodetic longitude:	5°00'00.000"E
ETRS-LAEA	northing (Y):	2999718.85 m	easting (X):	3962799.45m
ETRS89	geodetic latitude:	60°00'00.000"N	geodetic longitude:	5°00'00.000"E
ETRS-LAEA	northing (Y):	4109791.66 m	easting (X):	4041548.12 m

Inverse Conversion Computation

Examples

All EU projections are based on ETRS89 datum and therefore use ellipsoidal formulas. In some GIS applications the Lambert Azimuthal Equal Area method is implemented only in spherical form. Geodetic latitude and longitude must not be used in these spherical implementations. To do so may cause significant error (up to 15 km!). Use the example conversions above to test whether software uses appropriate formulas.

Caution

Appendix 1 - Brief biographies of the workshop participants



Iain Greenway

Iain Greenway completed a Master of Arts (MA) in Engineering at the University of Cambridge in 1986 and a Master of Science (MSc) in Land Surveying at University College London in 1987. He then joined Ordnance Survey of Great Britain. His work in the late 1980s and early 1990s included: i) Managing all GPS activity between 1988 and 1991, including the observation and computation of much of the National GPS Network; ii) Managing the large scale topographic mapping operations of one of Ordnance Survey's field offices; iii) A variety of geodetic projects in fields such as the depiction of magnetic declination on maps, and orthometric heighting with GPS; iv) Managing all geodetic survey and control operations and all aspects of the quality testing and inspection of maps; v) Overseeing the successful ISO9001 registration of OS's survey operations; vi) Consultancy in Bulgaria and Russia, in the use of GPS and the organisational arrangements needed to support the privatisation of farmland (working in PHARE and Know How Fund projects). His professional presentation to gain professional membership of the Royal Institution of Chartered Surveyors (RICS) in 1990 was on the use of kinematic GPS techniques for the updating of maps. In 1994-95, Iain studied for an MBA at Cranfield University, winning the Henry Ford II scholarship for top student. His subsequent work in Ordnance Survey included strategic planning, product management of the atlas and guide range, responsibility for all of Ordnance Survey's indirect channels to market, and management consultancy in Swaziland and Lesotho to assist the development of the national land and survey authorities. In 1999-2000, Iain was seconded to HM Treasury, supporting a team of top public and private sector managers in improving public sector productivity. Iain is currently Deputy Director at Ordnance Survey Ireland. As such, he is responsible for all operations and for much of the day-to-day management of the organisation. Particular current aspects include the implementation of a variety of new technologies, preparing for the move of Ordnance Survey Ireland to State Body status, and introducing a new coordinate reference system for Ireland. Iain is a member of Management and Editorial Boards of the primary journal Survey Review. He was Secretary of FIG (the International Federation of Surveying) commission 5 (Positioning and Measurement) 1994-98 and is currently the chair of FIG's Task Force on Standards and head of the RICS' delegation to FIG. He has authored a number of papers of the development of the survey profession, geodesy and GPS, standards, professional ethics and management issues.



Lars E. Engberg

Lars E. Engberg obtained his masters degree from the Royal Institute of Technology in Stockholm 1973. He has been working as a lecturer in geodesy at the School of Surveying for many years. Between 1989 and 1996 he was at the City Surveying Department in Stockholm and responsible for the establishment of an improved reference network in Greater Stockholm. Since 1996 he is working at the Geodetic Research Department at the National Land Survey of Sweden.

At present he is involved in a national project aiming to implement a new map projection together with the new reference frame SWEREF 99 as a national standard. He is a member of the Nordic Commission of Geodesy as well as the Swedish Cartographic Society.



Lysandros Tsoulos

Lysandros Tsoulos is Associate Professor at the National Technical University of Athens. He holds a degree in Surveying Engineering [1972] from the University of Thessaloniki, and a Doctor's degree in Computer Mapping [1990] from the National Technical University of Athens. He served as head of the Cartography Department and the Computing Center of the Hellenic Navy Hydrographic Service [1978–1990]. He studied Computer Mapping at the Department of

Geography, University of Wisconsin - Madison. His research interests include cartographic generalization, cartographic composition - expert systems and electronic atlases. Dr. Tsoulos is scientific coordinator on a number of research projects funded by the Commission. He is the author of 51 papers presented in international conferences or published in scientific journals and a textbook on Digital Cartography.



Dr.-Ing. habil. Johannes Ihde

Johannes Ihde was Academic Assistant at the Institute for Theoretical and Physical Geodesy at the TU Dresden (1974-78). Then he was Research Assistant for satellite geodesy at the Research Center of the Kombinat Geodäsie und Kartographie in Leipzig (1978-83). He became Head of the Geodesy Group of the Research Center in 1983. In 1990 he moved to the Institut für Angewandte Geodäsie in Leipzig where he was Research Assistant (1990-94). In 1991 he had the habilitation at the TU Dresden on the subject geoid determination. In 1994 he became

Head of Unit Terrestrial Geodesy at the Institute for Applied Geodesy (since 1997 Federal Agency for Cartography and Geodesy). Since 1996 he is actively involved on standardisation (collaboration in CEN/TC 287 Geographic information, WG 4, Position – Editor of WI 11 “Spatial Referencing by Coordinates” in ISO/TC 211 Geographic information–Representative of IAG, liaison member of ISO/TC 211). Since 1997 he is permanent guest in the Technical Working Group of the IAG Subcommittee for Europe (EUREF). Since 2000 he is Head of Unit Development and Data Management at the Federal Agency for Cartography and Geodesy.



Heinz Bennat

After obtaining a diploma in Geography at the University of Göttingen in 1984 he worked in a project of the German Research Foundation on the concept of a GIS for geomorphological applications. In 1987 he joined the Institute für Angewandte Geodäsie (IfAG), now Bundesamt für Kartographie und Geodäsie (BKG), to work in the fields of GIS, cartography and remote sensing of Antarctica. In 1989 he was co-author of recommendations for projections to be used in GIS and maps of

Antarctica. In 1995/96 he carried out a photogrammetric air survey and GPS measurements in Central Dronning Maud Land, Antarctica. In 1999 and 2000 he worked for the “Interministerieller Ausschuss für Geoinformationswesen” (IMAGI) on a concept for a German Geographic Data Infrastructure. Since August 2000 he is Project Manager for the EuroGeographics project SABE (Seamless Administrative Boundaries of Europe).



Manfred Oster

Studied geodesy at the university of Bonn from 1966 to 1971. After having finished his studies, he followed an additional education to enable access to the German public service from 1971 to 1974. He then entered the public service and became head of the section “Official Topographic Maps, Derivation of Thematic Maps” within the department of “Geotopography and Cartography” in the Surveying and Mapping Agency of Nordrhein-Westfalen (Germany). He was involved in the initial conception phase of the German ATKIS-project from 1986 to 1989. At present, Manfred Oster is responsible for organising the transition from traditional cartographic working procedures to modern digital techniques in the framework of updating and publishing official topographic and thematic maps in Nordrhein-Westfalen. He chairs the examination committee for young cartography trainees and is involved in the training program for students applying for access to the public service. He is author of several articles in the “Kartographische Nachrichten” edited by the German Cartographic Society dealing with issues like new techniques for updating maps, cartographic projections, representation of magnetic anomalies, new concepts for representing heights etc.



Marcus Wandinger

Obtained his degree (Dipl.-Ing. univ.) in Surveying/Geodesy at Technische Universität München in 1989. After a two-years preparatory service as civil servant, he started 1991 within the Bavarian Organisation for Land Surveying and Cadastre in the fields of application software developing for the cadastre base data GIS of this organisation. 1994 he changed to the Bavarian State Ministry for Financial affairs, where he has been involved in a wide range of tasks which included dealing with questions of citizens against the Bavarian Organisation of Land Survey and Cadastre. He also was and still is in charge of standardisation and therefore member of the standardisation working group on Geoinformation within DIN (Deutsches Institut für Normung e.V.). From March 1998 to March 2000, he was seconded to MEGRIN where he was mainly involved in GI metadata projects to set up pan-European Internet metadata services. Since his return to Bavaria, he took over responsibility as the personal assistant of the president of the Bavarian Mapping Agency. His tasks include the coordination of the international relations of his organisation. Further on, he is the designated congress director for the FIG 2006 congress. He is author and co-author of more than 20 papers and publications both in the fields of surveying as well as mining including mine surveying and mining history where he developed a deep interest since his studies. His ability to communicate in German, English, French and Spanish, facilitates a lot his international activities and interests.



Roger Lott

After graduating from the University of Newcastle upon Tyne, UK, in geography and surveying Roger worked in Survey Department of Jamaica in a variety of roles. He joined BP in 1973 and has worked worldwide on land, airborne and hydrographic survey projects in support of oil and gas exploration, production and spatial data management. He was appointed BP's Chief Surveyor in 1992. He is a Fellow of the Royal Institution of Chartered Surveyors (RICS), and current chairman of the European Petroleum Survey Group (EPSG).



Stefan A. Voser

He received his degree as an Engineer in Surveying/Geodesy (Dipl.-Verm.-Ing. ETH) at the Swiss Federal Institute of Technology (ETH) Zurich in 1994. His diploma thesis "Updating topographic data using digital orthophotos" was awarded by the Swiss Society of Surveyors and Rural Engineers (SVVK). From July 1994 to December 1996, he joined the GIS group of the Institute of Geodesy at the University of the Federal Armed Forces in Munich (UniBwM). His work focussed

on GI-application design and implementation for German government agencies. The main tasks thereby were georeferencing procedures of national and international datasets. His main project, funded by the German Federal Agency for Nature Conservation (BfN) in Bonn, dealt with the homogenisation of coordinate reference systems mainly of national and international European datasets. Upon completion of the project, he began to publish the collected parameters of European Map Projections and Reference Systems in the internet. His MapRef collection may be found at <http://www.mapref.org/>.

From January 1997 to September 1999, Stefan worked part time at the University of Vechta (Germany) on the project "Virtual GIS" that was founded by the German Science Foundation (DfG). The project was a member of the GI-semantic modelling group of the DfG. His main focus within the project was the conceptual design and information management of GI-operations/spatial analysis. One of its aspects was hybrid analysis, meaning the metric interaction between raster and vector data. In his "freetime", he still continues his work on coordinate reference systems, and during the summer semester 1999, he held a lecture on this topic at the University of Münster (Germany). Since October 1999, he works for the Swiss Federal Office of Topography (L+T), the Swiss national mapping agency, at Wabern. There he is responsible for the conceptual design and development of the 5th topographic land survey of Switzerland: The future Topographic Landscape Model (TLM) of Switzerland should become a 3D-database that is connected to various databases and applications within the Swiss government.



Christoph Branderberger

Christoph Branderberger hold a diploma in Surveying Engineering (1973) and a Ph.D. (1985) from the Swiss Federal Institute of Technology (ETHZ) in Zürich. Before coming to the Institute of Cartography at ETHZ (1977) as a scientific researcher and collaborator, he worked as a surveying engineer in a private surveying office for 4 years. During this period he passed the federal exam to get the patent as an official surveying engineer. Christoph Branderberger was involved in the production of the new Swiss World Atlas. For this project he computed numerous transformation between different map projections. Beside these works he also established various atlas maps in digital manner. His actual main research interests focus on: map projections, on-line map projection computations, vectorial and pixel data transformation between different map projections, program-supported generalization as also the digital production of hill shadings based upon DEM's. Dr. Ch. Branderberger is the author of several papers presented in international conferences or published in scientific journals and he has published a catalogue of possible map projections for world maps. He is a long-standing member of the Swiss Society of Cartography (SGK).

Appendix 2 – Contributors

Gabriela Augusto

European Topic Centre on Nature Conservation
(ETC/NC)
Muséum National d'Histoire Naturelle, Paris, France

Christoph Brandenberger

Institut für Kartographie, ETH Honggerberg
CH 8093 Zurich, Switzerland

Francis Dhee

Cellule Pédagogique et de Recherche en Cartographie
Ecole Nationale des Sciences Géographiques
Marne la Vallée, France

Lars Engberg

NLS Sweden, Geodetic Research Department
National Land Survey of Sweden, Lantmäteriet,
Sweden

Iain Greenway

Ordnance Survey Ireland

Johannes Ihde

Bundesamt für Kartographie und Geodäsie,
Abteilung Geodäsie
Außenstelle Leipzig, Karl-Rothe-Straße 10-14
D-04105 Leipzig, Germany

Roger Lott

BP Exploration, 200 Chertsey Road,
Sunbury on Thames, Middlesex TW16 7LN,
United Kingdom

Jean-Philippe Lagrange

Institut Géographique National

Peter G.M. Mekenkamp

Utrecht University, Faculty of Geographical Sciences
Section Cartography, P.O. Box 80.115, 3508 TC
Utrecht

Manfred Oster

Geotopographie und Kartographie
Landesvermessungsamt Nordrhein-Westfalen
Muffendorfer Straße 19-21, 53177 Bonn
(Bad Godesberg), Germany

Marc Roekaerts

European Topic Centre on Nature Conservation
(EEA-ETC/NC)

Lysandros Tsoulos

Faculty of Rural and Surveying Engineering
National Technical University of Athens
9.H.Polytechniou Str., 157 80 Zographou Campus,
Athens, Greece

Stefan A. Voser

Switzerland
www.mapref.org

Marcus Wandinger

Der Persönliche Referent des Präsidenten
Bayerisches Landesvermessungsamt
Alexandrastraße 4, 80538 München, Germany

C. Luzet

EuroGeographics
6 et 8, Avenue Blaise Pascal, Cité Descartes,
Champs-sur-Marne
77455 Marne la Vallée Cedex 2, France

Tim Hancock

EuroGeographics
6 et 8, Avenue Blaise Pascal, Cité Descartes,
Champs-sur-Marne
77455 Marne la Vallée Cedex 2, France

Alessandro Annoni

Joint Research Centre
Institute for Environment and Sustainability
21020 Ispra (VA), Italy

Albrecht Wirthmann

Eurostat
Unit E4, GISCO
Jean Monnet Building-L-2920 Luxembourg

Jacques Delince

Eurostat
Unit F2,
Batiment Jean Monnet, Rue Alcide de Gasperi
L-2920 Luxembourg

Jean Francois Dallemard

Joint Research Centre
Institute for Environment and Sustainability
TP 262, I-21020 Ispra (Va), Italy

Vanda Perdigão

Joint Research Centre
Institute for Environment and Sustainability
TP 262, I-21020 Ispra (Va), Italy

Chris Steenmans

European Environment Agency,
Kongens Nyrtov 6, DK-1051, Copenhagen, Denmark

J. Luthardt

BKG - Bundesamt für Kartographie und Geodäsie,
Außenst. Leipzig, Karl-Rothe-Str. 10-14, 04105
Leipzig, Germany

C. Boucher

IERS - Ministère de l'Éducation Nationale de la
Recherche et de la Technologie, Direction de la
Technologie, Département Espace et Aéronautique, 1
rue Descartes, 75231 Paris Cedex 05, France

P. Dunkley

EUROCONTROL
EATCHIP Implementation, Rue de la Fusee 96,
1130 Brussels, Belgium

E. Gubler

CERCO, WG VIII
Bundesamt für Landestopographie, Seftigenstrasse
264, 3084 Wabern, Switzerland

B. Farrell

MEGRIN

6-8 Avenue Braise Pascal, Cité des Cartes, Champs
sur Marne, 77455 Marne la Vallée, Cedex 2, France

J.A. Torres

EUREF

Instituto Portugues de Cartografia e Cadastral,
Rua Artilharia Um, 107, 1099-052 Lisboa, Portugal

Heinz Bennat

Bundesamt für Kartographie und Geodäsie
Richard-Strauss-Allee 11, D-60598 Frankfurt,
Germany

Jürgen Brennecke

Bundesamt für Kartographie und Geodäsie
Richard-Strauss-Allee 11, D-60598 Frankfurt,
Germany

Manfred Duster

Bundesamt für Kartographie und Geodäsie
Richard-Strauss-Allee 11, D-60598 Frankfurt,
Germany

Andreas Illert

Bundesamt für Kartographie und Geodäsie
Richard-Strauss-Allee 11, D-60598 Frankfurt,
Germany

Wolfgang Mehlitz

Bundesamt für Kartographie und Geodäsie
Richard-Strauss-Allee 11, D-60598 Frankfurt,
Germany

Ingrid Naumann

Bundesamt für Kartographie und Geodäsie
Richard-Strauss-Allee 11, D-60598 Frankfurt,
Germany

Wolfgang Augath

Geodätisches Institut, Technische Universität Dresden,
Mommsenstrasse 13, D-01062 Dresden, Germany